

G

I

A

R

N

I

—

—

—

R

I

**Think
light
Make
light
Love
light**

ALLEN	214
ASTER	58
BABOL	220
BELL	12
BILDE	96
BLOB	180
CORBA	226
DROP	84
KAMAK	234
MIKADO	156
ORIONE	188
PIXEL	136
PLISSÈ	26
PLUG	200
RAKE	112
RANTAN	44
REVIEW	106
SPOKE	122
STEP	166
SURF	146
TILT	76
WOW	206

The shape of light



Nelle proposte dal design fresco e originale di Giarnieri Light si trova la traccia del pensiero di Lucia, Enrico e Antonio, i tre fratelli a capo dell'azienda: unire nell'illuminazione di oggi tecnologia ed estetica, conferendogli un aspetto accattivante, contemporaneo, dallo spirito giovane e alla portata di tutti, ma sempre con un cuore pulsante altamente tecnologico, il LED. La luce del futuro continua ad evolversi, fa nascere soluzioni inedite e implementa le collezioni di successo, tutte rigorosamente Made in Italy.

The philosophy of Lucia, Enrico and Antonio, the brother and sister team in charge at Giarnieri Light, plays a role in the fresh, original design of the company's new range of products: a combination of modern technology and aesthetics, resulting in captivating, contemporary products featuring a youthful spirit and solutions to suit every pocket, and all based on the use of LED technology. The continuous evolution of the lighting technologies of the future is the motor that drives the creation of brand new solutions and successful collections, and all rigorously Made in Italy.



Think light





Make light

GIARNIERI
contemporary light

Il Volume N.3 porta in scena una grande novità nel mondo Giarnieri Light. L'animo giovane, ricco di colori, forme pulite e soluzioni componibili, si arricchisce di un nuovo materiale, il vetro. Ecco che affianco alle tante proposte dove il metallo è protagonista, troviamo le novità in vetro soffiato.

Volume N.3 sees the advent of a major innovation from the world of Giarnieri Light. The youthful soul, richness of colours, clean lines and modular solutions are enriched with the use of a new material, glass. In fact, in addition to our wide variety of metal solutions, we now offer a new range blown glass solutions products.

Un materiale dalle origini antiche ma sempre attuale, plasmato secondo il gusto estetico Giarnieri Light che mette in luce il dialogo costante tra passato e futuro, alternando collezioni dal gusto retrò a quelle con un design contemporaneo audace. Che sia vetro o metallo, entrambi si uniscono sempre ai principi di semplicità delle linee e all'applicazione della tecnologia LED.

A material that, despite its ancient origins, is never out of date, moulded according to the aesthetic taste of Giarnieri Light to highlight the constant dialogue between past and future and create collections that alternate between retro styles, and bold contemporary designs. Irrespective of whether they are realised in glass or metal, our creations combine simple, clean lines with the use of LED technology.

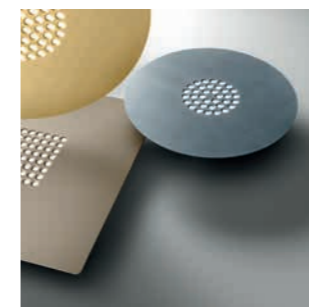

TECNOLOGIE INNOVATIVE E
ESPERIENZA ARTIGIANALE

INNOVATIVE TECHNOLOGIES
AND CRAFTS EXPERIENCE

Il LED con un'anima si mostra in tutta la sua bellezza nelle tante proposte Giarnieri Light. Da oggi puoi scegliere se vestire gli ambienti con il vetro, con linee totalmente inedite, o con il metallo dove sono presenti tante nuove proposte ma anche le collezioni di successo, implementate e arricchite di nuove forme e colori.

The LED with a soul reveals itself in all its beauty in the wide range of Giarnieri Light creations. Today, you can choose between an entirely new range of designs in glass or our metal solutions, featuring many new creations together with our existing collections, enriched with new shapes and colours.

Love light

DECOR 2019 COLLECTION



Bell 12



Plissé 26



Rantan 44



Aster 58

DESIGN 2019 COLLECTION

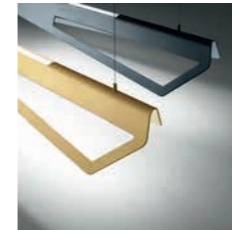

Tilt 76



Drop 84



Bilde 96

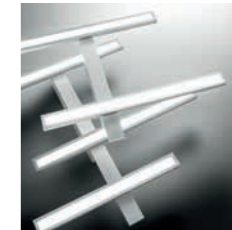

Review 106

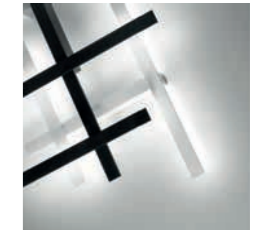

Rake 112



Spoke 122



Pixel 136



Surf 146



Mikado 156



Step 166



Blob 180



Orione 188



Plug 200



Wow 206

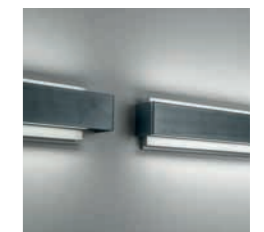

Allen 214



Babol 220

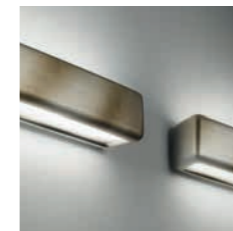

Corba 226



Kamak 234

GIARNIERI
contemporary light

DECOR

COLLECTION

DECOR
2019 COLLECTION

Lo stile italiano ad alta tecnologia
LED incontra l'eleganza della
tradizione vetraia.

Italian high technology LED style
meets the elegance of the glass
tradition.

Lo stile italiano ad alta tecnologia LED incontra l'eleganza della tradizione vetraia.

Giarnieri Light oggi presenta una collezione esclusiva, dove la magia del vetro soffiato da maestri muranesi si sposa con la scienza applicata all'illuminazione. Si delinea un nuovo orizzonte della tecnologia LED che si veste di un nuovo abito, prezioso e dalle linee più che mai attuali, esaltate dalla scelta di colori moderni come il blu, il verde e l'ambra desaturati o gli intensi bianco e ambra incamiciati.

Italian high technology LED style meets the elegance of the glass tradition.

Giarnieri Light is proud to present an exclusive collection, where the magic of Murano blown glass is combined with the science of lighting. A new horizon in LED technology and an entirely new look, featuring refined, state-of-the-art lines and enhanced by the choice of modern colours, such as desaturated blue, green and amber or intense layered white and amber.

DECOR
2019 COLLECTION

BELL

Design: Enrico Martini - desall.com

Sinfonie che
illuminano la notte.
Symphonies to
illuminate the night.

Crea la tua melodia con Bell, un rintocco di luce che richiama le lampade delle case italiane di un tempo, riviste nella forma, più lineare, e nei colori dal brio contemporaneo. Questa campana in vetro è disponibile in più dimensioni, singola o in composizioni a 3, a 5 oppure a 7 corpi, così da poter creare ognuno la propria armonia di luce, sempre con tecnologia LED.

Create your melody with Bell, a touch of light that recalls the lamps used in traditional Italian houses, featuring a revised, more linear form and in the colours selected to lend a contemporary panache. This glass bell is available in multiple sizes, and in single or 3, 5 or 7 body compositions, so that everyone can create their own harmony of light, using LED technology, naturally.









Le composizioni multiple danno un tocco di dinamismo, per un effetto ancora più vivace. In tutte e tre le soluzioni a 3, 5 o 7 corpi, puoi scegliere i diffusori in colori differenti tra loro.

The multiple compositions lend a touch of dynamism, for an even more lively effect. All three 3, 5 or 7 body solutions are also available with the diffusers in differing of colours.







Bell può essere in colorazioni trasparenti oppure nelle versioni ambra o bianco incamiciato, ottenendo una luce più soffusa e delicata.

Bell is available in transparent colours, or in layered amber or white jacketed versions, for a softer and more delicate light.



BELL

Lampada con struttura in alluminio pressofuso e diffusore in vetro soffiato. Struttura disponibile nei colori bianco opaco o nero opaco. Sorgente luminosa Led dimmerabile. Diffusore in vetro disponibile in bianco incamiciato, ambra incamiciato, ambra trasparente, blu trasparente o verde trasparente. Illuminazione diretta.

Lamp with die-cast aluminium structure and blown glass diffuser. Structure available in matt white or matt black. Dimmable LED light source. Glass diffuser in multi-layered white, multi-layered amber, transparent amber, transparent blue or transparent green. Direct lighting.

Dimmer compatibile disponibile a pag. 240.

Compatible dimmer available on page 240.

SOSPENSIONE SINGOLA PICCOLA

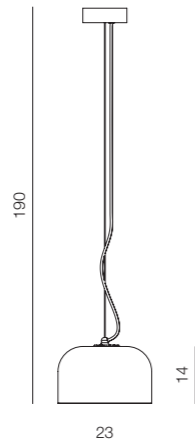

LED

1 LED
1x12W
220/240V
1200lm
3000K - CRI >80
Class A+

Disponibili su richiesta moduli con temperatura 4000K.
4000K temperature modules available on request.

SOSPENSIONE SINGOLA GRANDE

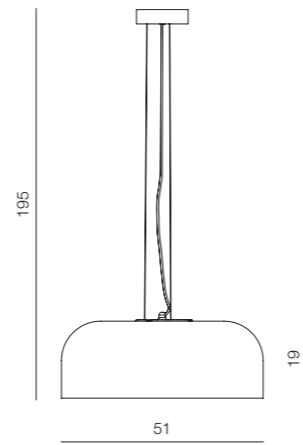

LED

1 LED
1x23W
220/240V
2300lm
3000K - CRI >80
Class A+

SOSPENSIONE MULTIPLA 3 LED

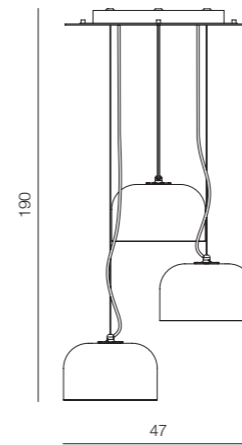

LED

3 LED
3x12W
220/240V
3600lm
3000K - CRI >80
Class A+

Disponibili su richiesta moduli con temperatura 4000K.
4000K temperature modules available on request.

SOSPENSIONE MULTIPLA 5 LED

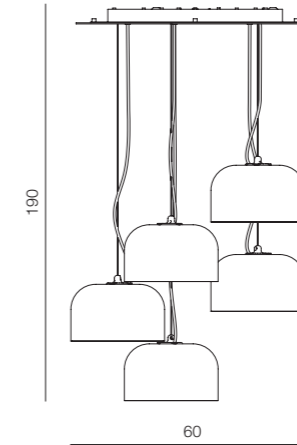

LED

5 LED
5x12W
220/240V
6000lm
3000K - CRI >80
Class A+

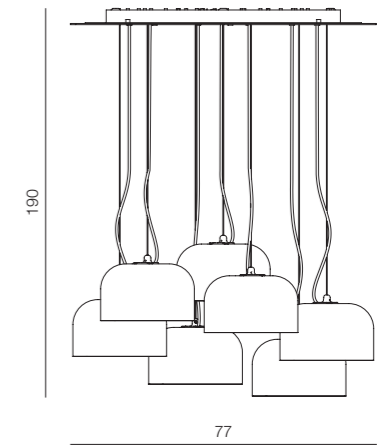

SOSPENSIONE MULTIPLA 7 LED







LED

7 LED
7x12W
220/240V
8400lm
3000K - CRI >80
Class A+

CODICI STRUTTURA IN ALLUMINIO

FINISHES	CODE	CODE	CODE	CODE	CODE
 Bianco opaco / Matt white	LS B	LL B	L3 B	L5 B	L7 B
 Nero opaco / Matt black	LS N	LL N	L3 N	L5 N	L7 N

CODICI VETRI SINGOLI

FINISHES	CODE	CODE	CODE	CODE	CODE
 Ambra incamiciato / Multi-layered amber	BELL S AI	BELL L AI	BELL S AI	BELL S AI	BELL S AI
 Ambra trasparente / Transparent amber	BELL S AT	BELL L AT	BELL S AT	BELL S AT	BELL S AT
 Bianco incamiciato / Multi-layered white	BELL S BI	BELL L BI	BELL S BI	BELL S BI	BELL S BI
 Blu trasparente / Transparent blue	BELL S BT	BELL L BT	BELL S BT	BELL S BT	BELL S BT
 Verde trasparente / Transparent green	BELL S VT	BELL L VT	BELL S VT	BELL S VT	BELL S VT

CONFIGURAZIONE ORDINE
Bell è un prodotto configurabile in base alle vostre esigenze. Potete scegliere il colore della struttura e dei singoli vetri.

ORDER CONFIGURATION
Bell is a customisable product. Customers can choose the colour of its structure and individual types of glass.

PLISSÉ
SUSPENSION

Morbide trasparenze di luce.
Soft, transparent light.

Una luce romantica si posa sugli ambienti con Plissé. Il vetro increspato in tante piccole onde regala armonia a questa lampada a sospensione che ricorda un calice rovesciato, perfetto per brindare alle serate più dolci. Per sottolineare l'effetto di luce che la lavorazione conferisce, questa linea è disponibile sia con sorgente LED sia con attacco E27.

A romantic light settles on the rooms with Plissé. The numerous small waves of the rippled glass lend harmony to this pendant lamp that recalls an inverted goblet, ideal for toasting the most romantic evenings. To emphasise the effects produced by the glass, this line is available in both LED source and E27 socket versions.

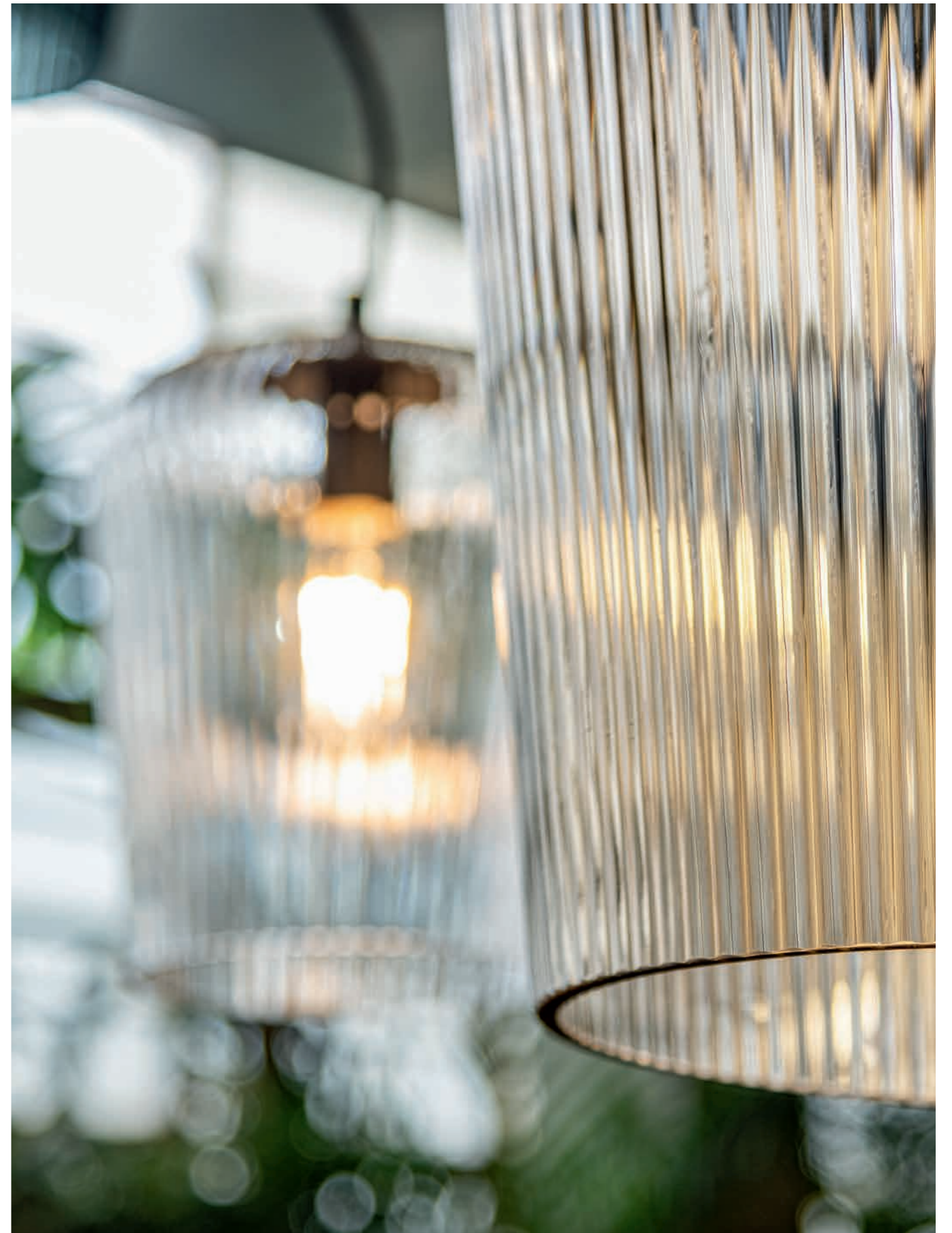



La scelta del colore incamiciato permette di esaltare le linee pulite e ricercate, i colori trasparenti invece giocano con la luce e la sua diffusione nell'ambiente.

The choice of layered colours enhances the clean, refined lines, while the transparent colours play with the light and the way it is diffused within the environment.







Plissé si propone singolo o a composizioni multiple a 3-5-7 corpi, per portare un tocco romantico in spazi di qualsiasi dimensione.

Plissé is available in single or multiple compositions, with 3, 5 or 7 bodies, guaranteeing a romantic touch irrespective of the space.





Hai l'imbarazzo della scelta nel comporre il tuo progetto grazie a due misure, da 23 o da 40 cm di diametro, due tipi d'illuminazione, LED o con attacco E27 e tanti colori, tra cui la tonalità cristallo.

The variety of sizes (23 or 40 cm in diameter), light sources (LED or E27), and the wide range of colours available, including crystal hues, means you will be spoilt for choice when creating your project.





La particolare lavorazione a coste del vetro, unita all'attacco E27, crea nell'ambiente un delicato effetto luminoso filtrato.

The special ribbed glass, combined with the E27 fitting lends a delicate filtered lighting effect to the environment.



PLISSÉ

Lampada con struttura in alluminio pressofuso e diffusore in vetro soffiato. Struttura disponibile nei colori bianco opaco o nero opaco e in due varianti di sorgente luminosa: Led dimmerabile o lampadina E27. Lampadina non inclusa nella versione E27. Diffusore in vetro disponibile in bianco incamiciato, ambra trasparente, cristallo trasparente, blu trasparente o verde trasparente. Illuminazione diretta.

Lamp with die-cast aluminium structure and blown glass diffuser. Structure available in matt white or matt black and with two light source variants: Dimmable LED or E27 bulb. Bulb not included in E27 version. Glass diffusers in multi-layered white, transparent amber, transparent crystal, transparent blue or transparent green. Direct lighting.

Dimmer compatibile per versione LED disponibile a pag. 240.

Compatible dimmer for LED version available on page 240.

SOSPENSIONE SINGOLA PICCOLA

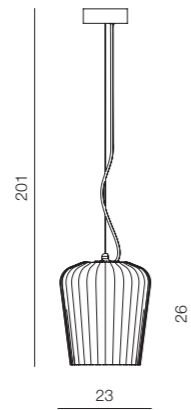

LED

1 LED
1x12W
220/240V
1200lm
3000K - CRI >80
Class A+

E27

1 E27
Max 1x77W
Class E / A+

Disponibili su richiesta moduli con temperatura 4000K. 4000K temperature modules available on request.

SOSPENSIONE SINGOLA GRANDE

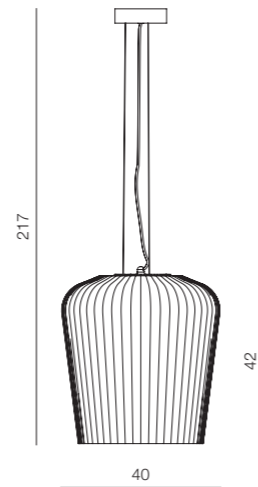

LED

1 LED
1x23W
220/240V
2300lm
3000K - CRI >80
Class A+

E27

1 E27
Max 1x105W
Class E / A+

SOSPENSIONE MULTIPLA 3 LED / 3 E27

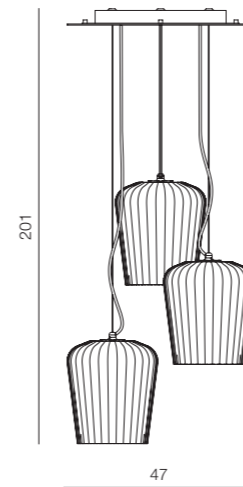

LED

3 LED
3x12W
220/240V
3600lm
3000K - CRI >80
Class A+

E27

3 E27
Max 3x77W
Class E / A+

Disponibili su richiesta moduli con temperatura 4000K. 4000K temperature modules available on request.

SOSPENSIONE MULTIPLA 5 LED / 5 E27

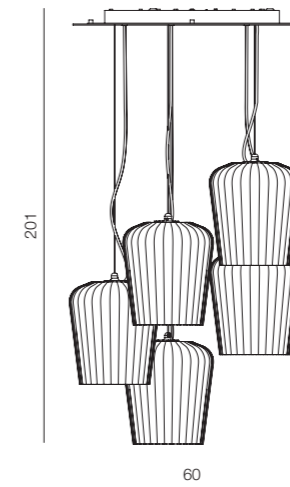

LED

5 LED
5x12W
220/240V
6000lm
3000K - CRI >80
Class A+

E27

5 E27
Max 5x77W
Class E / A+

Disponibili su richiesta moduli con temperatura 4000K. 4000K temperature modules available on request.

SOSPENSIONE MULTIPLA 7 LED / 7 E27

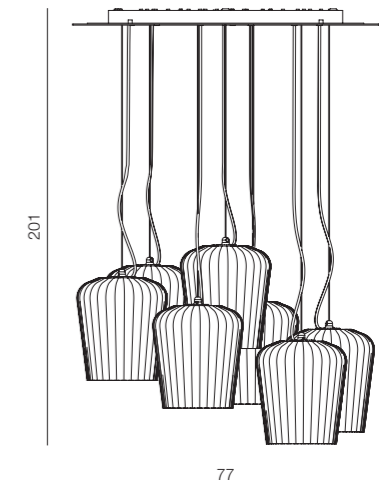

LED

7 LED
7x12W
220/240V
8400lm
3000K - CRI >80
Class A+

E27

7 E27
Max 7x77W
Class E / A+

Disponibili su richiesta moduli con temperatura 4000K. 4000K temperature modules available on request.

CODICI STRUTTURA IN ALLUMINIO

FINISHES	CODE	CODE	CODE	CODE	CODE	CODE	CODE	CODE	CODE	
Bianco opaco / Matt white	LS B	ESC B	LL B	ELC B	L3 B	E3C B	L5 B	E5C B	L7 B	E7C B
Nero opaco / Matt black	LS N	ESC N	LL N	ELC N	L3 N	E3C N	L5 N	E5C N	L7 N	E7C N

CODICI VETRI SINGOLI

FINISHES	CODE	CODE	CODE	CODE	CODE
Ambra trasparente / Transparent amber	PLISSÉ S AT	PLISSÉ L AT	PLISSÉ S AT	PLISSÉ S AT	PLISSÉ S AT
Bianco incamiciato / Multi-layered white	PLISSÉ S BI	PLISSÉ L BI	PLISSÉ S BI	PLISSÉ S BI	PLISSÉ S BI
Blu trasparente / Transparent blue	PLISSÉ S BT	PLISSÉ L BT	PLISSÉ S BT	PLISSÉ S BT	PLISSÉ S BT
Cristallo trasparente / Transparent crystal	PLISSÉ S CT	PLISSÉ L CT	PLISSÉ S CT	PLISSÉ S CT	PLISSÉ S CT
Verde trasparente / Transparent green	PLISSÉ S VT	PLISSÉ L VT	PLISSÉ S VT	PLISSÉ S VT	PLISSÉ S VT

CONFIGURAZIONE ORDINE
Plissé è un prodotto configurabile in base alle vostre esigenze. Potete scegliere il colore della struttura e dei singoli vetri.

ORDER CONFIGURATION
Plissé is a customisable product. Customers can choose the colour of its structure and individual types of glass.

RANTAN
SUSPENSION

L'incontro tra la
modernità e l'oriente.
A marriage of the
modern and the Orient.

Una lanterna d'oriente che fluttua sospesa nell'aria ad accompagnare i sogni della sera. La luce filtra colorata attraverso le trasparenze del vetro, l'atmosfera si fa rilassata e lo sguardo resta ipnotizzato dalla figura slanciata di Rantan che illumina con la sua luce diretta.

An oriental lantern that floats suspended in the air to accompany the dreams of the evening. The coloured light filters through the transparent glass, creating a relaxing atmosphere, while the gaze is mesmerised by the slender figure of Rantan, which illuminates with its direct light.





Nei progetti d'illuminazione è bello poter creare più combinazioni accostando tra loro diverse dimensioni e colori.

When designing lighting projects it is nice to be able to create more combinations by combining different sizes and colours.





Rantan è disponibile singolo in tre dimensioni differenti:
12 - 15 o 23 cm di diametro.
Tutti i modelli hanno l'attacco E27.

Rantan is available as a single element
in diameters of 12, 15 or 23 cm.
All models feature E27 fittings.



Nelle composizioni multiple si possono scegliere tra due dimensioni dei vetri, piccoli o medi.

When creating multiple compositions, you can choose between two glass sizes, small or medium.





Per un maggior senso di movimento è possibile regolare i vari corpi ad altezze differenti, i cavi sono lunghi fino a 170 cm.

For a greater sense of movement it is possible to position the various bodies at different heights; the leads are up to 170 cm in length.

RANTAN

Lampada con struttura in alluminio e diffusore in vetro soffiato. Struttura disponibile nei colori bianco opaco o nero opaco. Sorgente luminosa lampadina E27. Lampadina non inclusa. Diffusore in vetro disponibile in bianco incamiciato, ambra trasparente, cristallo trasparente, blu trasparente o verde trasparente. Illuminazione diretta.

Lamp with aluminium structure and blown glass diffuser. Structure available in matt white or matt black. E27 bulb light source. Bulb not included. Glass diffusers in multi-layered white, transparent amber, transparent crystal, transparent blue or transparent green. Direct lighting.

<p>SOSPENSIONE SINGOLA PICCOLA</p> <p>204 12</p>	<p>SOSPENSIONE SINGOLA MEDIA</p> <p>204 15</p>	<p>SOSPENSIONE SINGOLA GRANDE</p> <p>219 23 44</p>	<p>SOSPENSIONE MULTIPLA 3 E27</p> <p>204 47</p>		<p>SOSPENSIONE MULTIPLA 5 E27</p> <p>204 60</p>		<p>SOSPENSIONE MULTIPLA 7 E27</p> <p>204 77</p>		
E27	E27	E27	E27	E27	E27	E27	E27	E27	E27
1 E27 Max 1x46W Class E / A+	1 E27 Max 1x56W Class E / A+	1 E27 Max 1x77W Class E / A+	3 E27 Max 3x46W Class E / A+	3 E27 Max 3x46W Class E / A+	5 E27 Max 5x46W Class E / A+	5 E27 Max 5x46W Class E / A+	7 E27 Max 7x46W Class E / A+	7 E27 Max 7x46W Class E / A+	7 E27 Max 7x46W Class E / A+

CODICI STRUTTURA IN ALLUMINIO

FINISHES	CODE	CODE	CODE	CODE	CODE	CODE	CODE	CODE	CODE
Bianco opaco / Matt white	ES B	ES B	EL B	E3 B	E3 B	E5 B	E5 B	E7 B	E7 B
Nero opaco / Matt black	ES N	ES N	EL N	E3 N	E3 N	E5 N	E5 N	E7 N	E7 N

CODICI VETRI SINGOLI

FINISHES	CODE	CODE	CODE	vetri piccoli small glasses CODE	vetri medi medium glasses CODE	vetri piccoli small glasses CODE	vetri medi medium glasses CODE	vetri piccoli small glasses CODE	vetri medi medium glasses CODE
Ambra trasparente / Transparent amber	RANTAN S AT	RANTAN M AT	RANTAN L AT	RANTAN S AT	RANTAN M AT	RANTAN S AT	RANTAN M AT	RANTAN S AT	RANTAN M AT
Bianco incamiciato / Multi-layered white	RANTAN S BI	RANTAN M BI	RANTAN L BI	RANTAN S BI	RANTAN M BI	RANTAN S BI	RANTAN M BI	RANTAN S BI	RANTAN M BI
Blu trasparente / Transparent blue	RANTAN S BT	RANTAN M BT	RANTAN L BT	RANTAN S BT	RANTAN M BT	RANTAN S BT	RANTAN M BT	RANTAN S BT	RANTAN M BT
Cristallo trasparente / Transparent crystal	RANTAN S CT	RANTAN M CT	RANTAN L CT	RANTAN S CT	RANTAN M CT	RANTAN S CT	RANTAN M CT	RANTAN S CT	RANTAN M CT
Verde trasparente / Transparent green	RANTAN S VT	RANTAN M VT	RANTAN L VT	RANTAN S VT	RANTAN M VT	RANTAN S VT	RANTAN M VT	RANTAN S VT	RANTAN M VT

CONFIGURAZIONE ORDINE
Rantan è un prodotto configurabile in base alle vostre esigenze. Potete scegliere il colore della struttura e dei singoli vetri.

ORDER CONFIGURATION
Rantan is a customisable product. Customers can choose the colour of its structure and individual types of glass.

ASTER
SUSPENSION

Un abbraccio di luce.
Caressed by the light.

Un'emozione tutta da scoprire, fatta di dolci linee curve che abbracciano lo sguardo e trasmettono un senso di serenità. Aster è la lampada a sospensione in vetro che nasce dalla linea avvolgente dell'arco, arricchito di linee orizzontali irregolari, il risultato è un movimento sinuoso che ricorda un tessuto adagiato o un'increspatura sull'acqua placida.

A brand new emotion, consisting of gentle, curved lines that embrace the eye and convey a sense of serenity. Aster is the pendant lamp in glass inspired by the all-embracing line of the arch, enriched with irregular, horizontal lines, the result is a sinuous movement that recalls an abandoned length of fabric or a ripple on still water.





Per un effetto più armonioso, i colori incamiciati sono proposti con cavo e montatura bianchi, mentre le finiture nere sono abbinare ai vetri colorati trasparenti.

For a more harmonious effect, the layered colours are available white leads and frames, while the black finishes are combined with coloured, transparent glass.





La creatività non vuole limitazioni, per questo tutti gli elementi possono essere abbinati tra loro: dai vetri, alle finiture, passando per la scelta dei modelli a sospensione multipla.

Creativity should not be bound by limitations; therefore it is possible to combine elements such as glass, fittings and multiple pendant solutions any way you see fit.





Le dimensioni generose del modello singolo più grande, ben 45 cm di diametro, ne fanno un protagonista dell'arredo.

The generous dimensions of the largest single model, a full 45 cm in diameter, ensure that it plays a significant role in defining the decor.



Aster è disponibile nei colori trasparenti ambra, blu e verde, oppure nei colori incamiciati e quindi più opachi, bianco oppure ambra.

Aster is available in transparent amber, blue and green colours, or in layered, and hence more opaque, white and amber versions.

ASTER

Lampada con struttura in alluminio e diffusore in vetro soffiato.
 Struttura disponibile nei colori bianco opaco o nero opaco.
 Sorgente luminosa lampadina E27.
 Lampadina non inclusa.
 Diffusore in vetro disponibile in bianco incamiciato, ambra incamiciato, ambra trasparente, blu trasparente o verde trasparente.
 Illuminazione diretta.

Lamp with aluminium structure and blown glass diffuser.
 Structure available in matt white or matt black.
 E27 bulb light source. Bulb not included.
 Glass diffuser in multi-layered white, multi-layered amber, transparent amber, transparent blue or transparent green.
 Direct lighting.

SOSPENSIONE SINGOLA PICCOLA

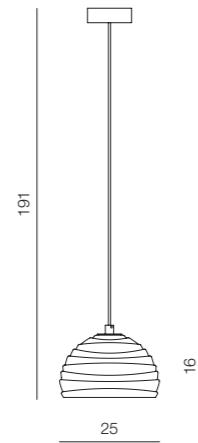

E27
 1 E27
 Max 1x77W
Class E / A+

SOSPENSIONE SINGOLA GRANDE

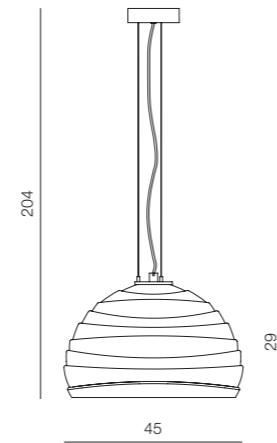

E27
 1 E27
 Max 1x105W
Class E / A+

SOSPENSIONE MULTIPLA 3 E27

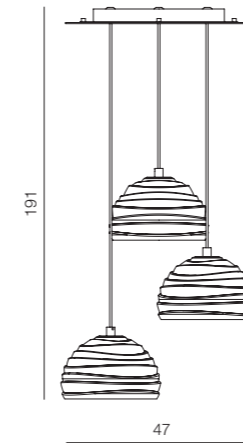

E27
 3 E27
 Max 3x77W
Class E / A+

SOSPENSIONE MULTIPLA 5 E27



E27
 5 E27
 Max 5x77W
Class E / A+

SOSPENSIONE MULTIPLA 7 E27

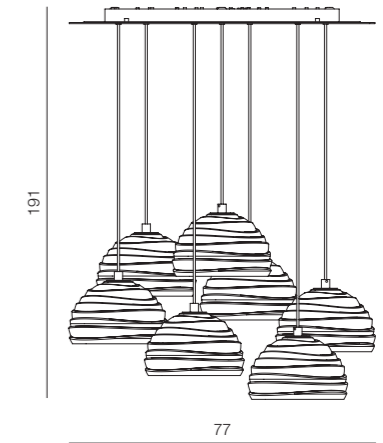

E27
 7 E27
 Max 7x77W
Class E / A+

CODICI STRUTTURA IN ALLUMINIO

FINISHES	CODE	CODE	CODE	CODE	CODE
Bianco opaco / Matt white	ES B	EXL B	E3 B	E5 B	E7 B
Nero opaco / Matt black	ES N	EXL N	E3 N	E5 N	E7 N

CODICI VETRI SINGOLI

FINISHES	CODE	CODE	CODE	CODE	CODE
Ambra incamiciato / Multi-layered amber	ASTER S AI	ASTER L AI	ASTER S AI	ASTER S AI	ASTER S AI
Ambra trasparente / Transparent amber	ASTER S AT	ASTER L AT	ASTER S AT	ASTER S AT	ASTER S AT
Bianco incamiciato / Multi-layered white	ASTER S BI	ASTER L BI	ASTER S BI	ASTER S BI	ASTER S BI
Blu trasparente / Transparent blue	ASTER S BT	ASTER L BT	ASTER S BT	ASTER S BT	ASTER S BT
Verde trasparente / Transparent green	ASTER S VT	ASTER L VT	ASTER S VT	ASTER S VT	ASTER S VT

CONFIGURAZIONE ORDINE
 Aster è un prodotto configurabile in base alle vostre esigenze.
 Potete scegliere il colore della struttura e dei singoli vetri.

ORDER CONFIGURATION
 Aster is a customisable product. Customers can choose the colour of its structure and individual types of glass.

GIARNIERI
contemporary light

DESIGN IGNITION

DESIGN
2019 COLLECTION

Un materiale semplice ed ecologico come l'alluminio dà vita a nuovi concetti illuminotecnici. Simple and ecological materials, such as aluminium, giving rise to new lighting concepts.

Un materiale semplice ed ecologico come l'alluminio viene lavorato e pressofuso, dando vita a nuovi concetti illuminotecnici, pensati per arredare gli ambienti attraverso la luce, con gusto e originalità.

Alla base della linea stilistica di Giarnieri Light c'è sempre la qualità della materia che viene esaltata attraverso lo studio di forme capaci di valorizzarne la purezza.

Simple and ecological materials, such as aluminium, are processed and die-cast, giving rise to new lighting concepts. The latter are designed to furnish rooms with light, taste and originality.

The quality of material is always fundamental in defining Giarnieri's style choices. This is enhanced through the study of forms capable of enhancing its purity.

DESIGN
2019 COLLECTION

TILT
SUSPENSION

Giochi prospettici.
Playing with perspective.

Le forme si deformano, la geometria scherza con la prospettiva e nasce Tilt. Una lampada a sospensione dal design slanciato e vigoroso, con linee ben definite, pulite e incisive. Attraverso i tagli laterali, presenti sul lungo corpo in alluminio, lascia intravedere un perfetto equilibrio di luce diretta e indiretta.

Shapes are deformed, geometry plays with perspective, and the result is....Tilt. A pendant lamp with a slender but vigorous design, featuring well-defined, clean and incisive lines. The lateral openings on the long aluminium body reveal the perfect balance between direct and indirect light.







Tilt è disponibile nei colori bianco, oro o piombo, tutte tonalità che, unite alle linee decise del corpo in metallo, lo rendono adatto sia agli ambienti domestici, sia agli uffici.

Tilt is available in white, gold or lead, all shades that, when combined with the strong lines of the metal body, make it suitable for both home and office environments.



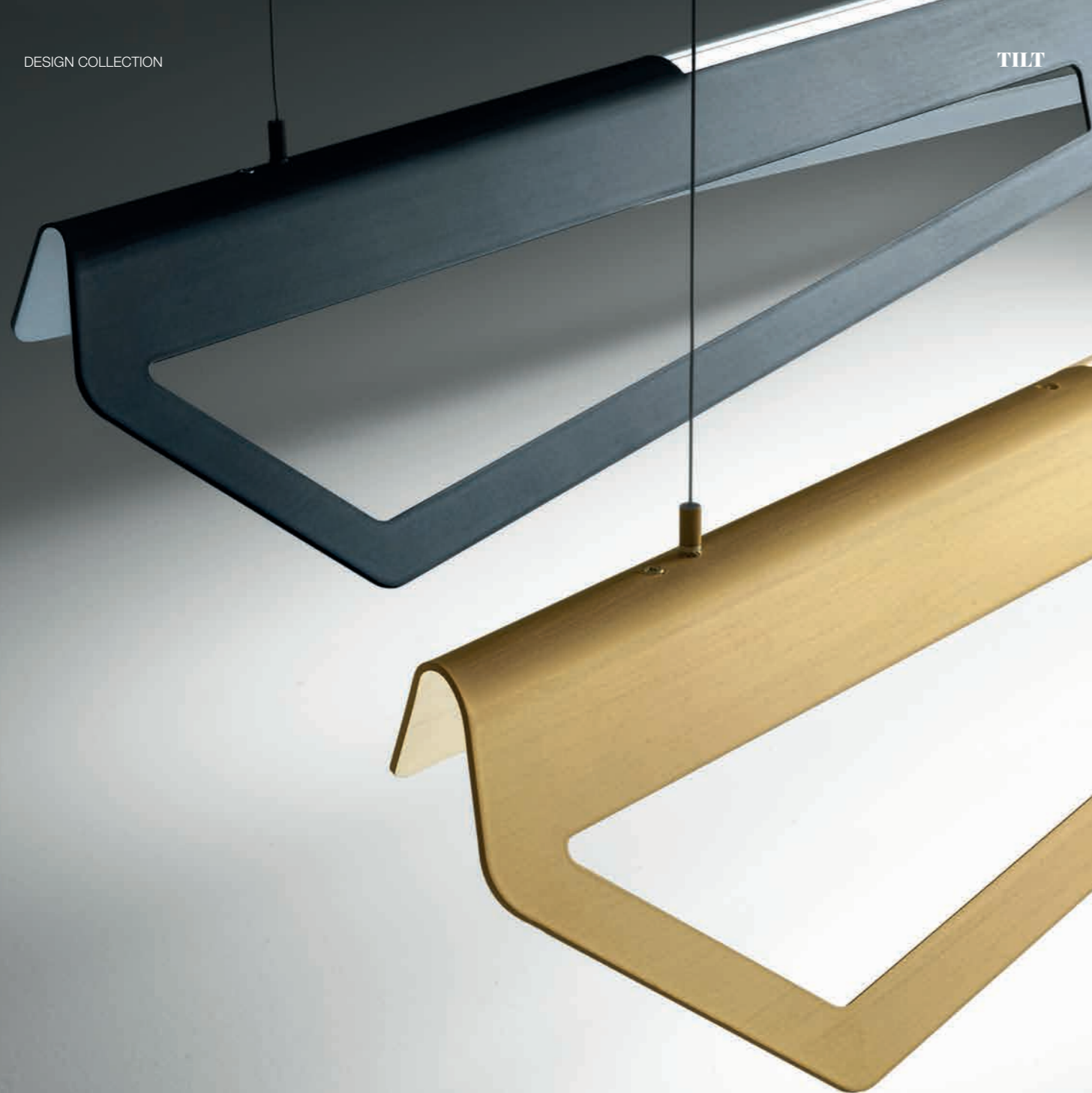

TILT

SUSPENSION

Lampada con struttura in alluminio, diffusore in metacrilato. Disponibile nei colori bianco opaco, piombo opaco ed oro opaco. Sorgente luminosa LED dimmerabile. Illuminazione diretta ed indiretta.

Lamp with aluminium structure and metacrylate diffuser. Available in matt white, matt lead and matt gold. Dimmable LED light source. Direct and indirect illumination.

Dimmer compatible disponibile a pag. 240.

Compatible dimmer available on page 240.

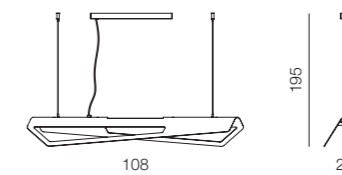

TILT S

4 moduli LED
3x13W (down) + 1x13W (up) = 52W
220/240V
5200lm
3000K - CRI >80
Class A+

Disponibili su richiesta moduli con temperatura 2700K o 4000K. 2700K or 4000K temperature modules available on request.

FINISHES

<input type="checkbox"/>	Bianco opaco / Matt white
<input type="checkbox"/>	Oro opaco / Matt gold
<input type="checkbox"/>	Piombo opaco / Matt lead

CODE

TILT S B

TILT S O

TILT S P

DROP
APPLIQUE
PLAFONE
SUSPENSION

La misura dello charme. The measure of charm.

Per creare atmosfere soffuse, che accolgono lo sguardo, Drop è la lampada ideale, con la sua forma che ricorda un leggero e sinuoso anello di fumo. Un richiamo al vintage anni sessanta per spessori e linee e una luce indiretta, raffinata e ricercata.

Drop, with its shape reminiscent of a light and sinuous smoke ring, is the ideal solution for creating suffused atmospheres to beguile and entrance the gaze. A homage to the sixties vintage thanks to the thickness of the elements, its lines and its indirect, refined light.





Quando c'è proporzione, bastano pochi elementi, la bellezza si mette a nudo e si mostra sotto forma di danza ipnotica.

When there is proportion, a few simple elements suffice, the beauty is revealed in the form of a hypnotic dance.



Drop è proposto in molte varianti e dimensioni, non solo a sospensione, ma anche a plafoniera.

Drop is available in many variations and sizes, not only as a pendant lamp, but also as ceiling versions.





Drop si colora con le nuove tinte inserite per le collezioni in metallo, non più solo bianco opaco e tortora, ma anche acciaio o bronzo anticati e il nuovissimo oro opaco.

Drop is available in the new colours introduced for the metal collections, no longer only matt white and taupe, but also steel or antique bronze, and the brand new matt gold.

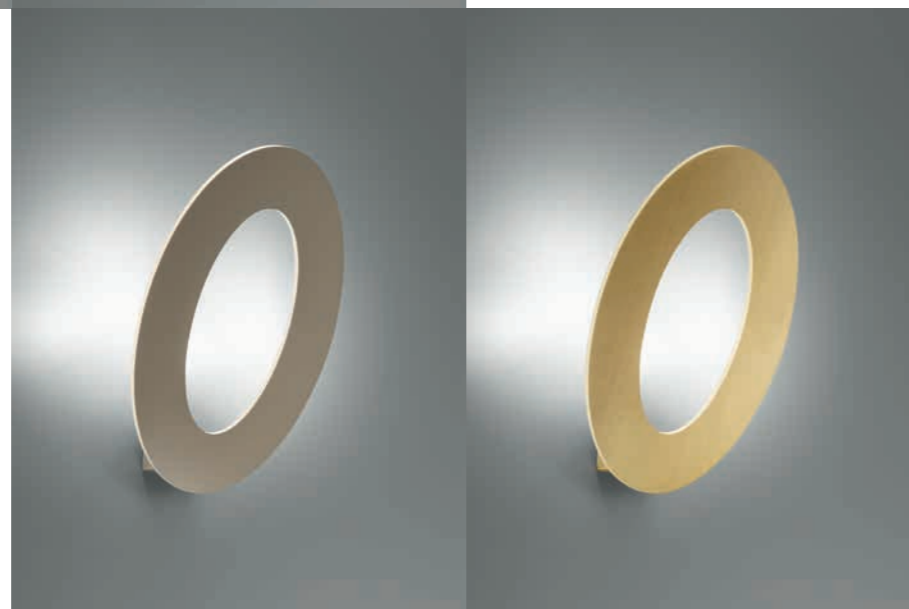
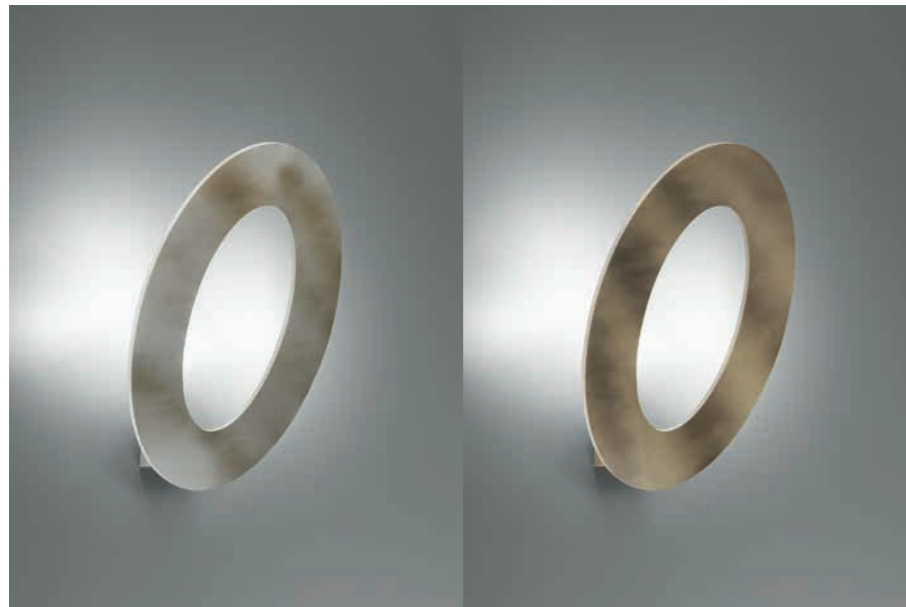

DROP
SUSPENSION

Lampada con struttura in alluminio, diffusore in metacrilato. Disponibile nei colori bianco opaco, tortora, oro opaco, anticato acciaio ed anticato bronzo. Sorgente luminosa COB LED dimmerabile. Illuminazione indiretta.

Lamp with aluminium structure and metacrylate diffuser. Available in matt white, dove grey, matt gold, antique steel and antique bronze. Dimmable COB LED light source. Indirect illumination.

Dimmer compatibile disponibile a pag. 240.
Per Drop S2 utilizzare 2 dimmer in modalità Master/Slave.

Compatible dimmer available on page 240. For Drop S2 use 2 dimmers in Master/Slave mode.

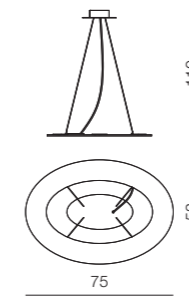

DROP SM

3 COB LED
3x20W = 60W
220/240V
5400lm
3000K - CRI >80
Class A+

Disponibili su richiesta moduli con temperatura 2700K o 4000K. 2700K or 4000K temperature modules available on request.

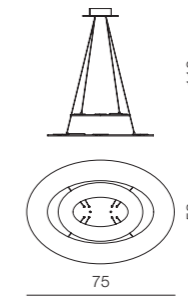

DROP S2 MINI

6 COB LED
3x8W + 3x20W = 84W
220/240V
7368lm
3000K - CRI >80
Class A+

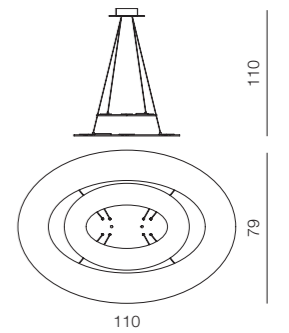

DROP S2

7 COB LED
7x20W = 140W
220/240V
12600lm
3000K - CRI >80
Class A+

FINISHES	CODE	CODE	CODE
Anticato acciaio / Antique steel	DROP SM AA	DROP S2 MINI AA	DROP S2 AA
Anticato bronzo / Antique bronze	DROP SM AB	DROP S2 MINI AB	DROP S2 AB
Bianco opaco / Matt white	DROP SM B	DROP S2 MINI B	DROP S2 B
Oro opaco / Matt gold	DROP SM O	DROP S2 MINI O	DROP S2 O
Tortora / Dove Grey	DROP SM T	DROP S2 MINI T	DROP S2 T

DROP
APPLIQUE / PLAFONE

Lampada con struttura in alluminio, diffusore in metacrilato. Disponibile nei colori bianco opaco, tortora, oro opaco, anticato acciaio ed anticato bronzo. Sorgente luminosa COB LED dimmerabile. Illuminazione indiretta.

Lamp with aluminium structure and metacrylate diffuser. Available in matt white, dove grey, matt gold, antique steel and antique bronze. Dimmable COB LED light source. Indirect illumination.

Dimmer compatibile disponibile a pag. 240.

Compatible dimmer available on page 240.

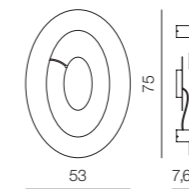

DROP PM

3 COB LED
3x20W = 60W
220/240V
5400lm
3000K - CRI >80
Class A+

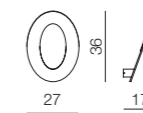

DROP A

2 COB LED
2x8W = 16W
220/240V
1312lm
3000K - CRI >80
Class A+

Disponibili su richiesta moduli con temperatura 2700K o 4000K. 2700K or 4000K temperature modules available on request.

FINISHES	CODE	CODE
Anticato acciaio / Antique steel	DROP PM AA	DROP A AA
Anticato bronzo / Antique bronze	DROP PM AB	DROP A AB
Bianco opaco / Matt white	DROP PM B	DROP A B
Oro opaco / Matt gold	DROP PM O	DROP A O
Tortora / Dove Grey	DROP PM T	DROP A T

BILDE
PLAFONE

Le opere d'arte
vivono di luce propria.
Works of art live
by their own light.

Spesso il segreto dell'eleganza si cela dietro ad una semplice formula, semplice ma infallibile. Bilde fa tesoro di questa regola e trasforma la purezza del quadrato in un omaggio alle opere d'avanguardia. La luce diretta si fa arte e si esprime in tutta la sua sincerità, per esaltarla serve solo una cornice dai tratti essenziali, pulita, genuina.

Often the secret of elegance lies in a simple formula; simple but infallible. Bilde takes advantage of this rule and transforms the purity of the square into a tribute to the avant-garde movement. Direct light becomes art and expresses itself in all its sincerity, exalted by the clean, honest lines of a simple frame.





Bilde, disponibile in 3 dimensioni, può avere la struttura in metallo bianca, per un effetto tono su tono, oppure si possono scegliere i due colori di tendenza oro e piombo opachi.

Bilde is available in 3 sizes and with a white metal structure, for a tone-on-tone effect, or in matt gold and lead.

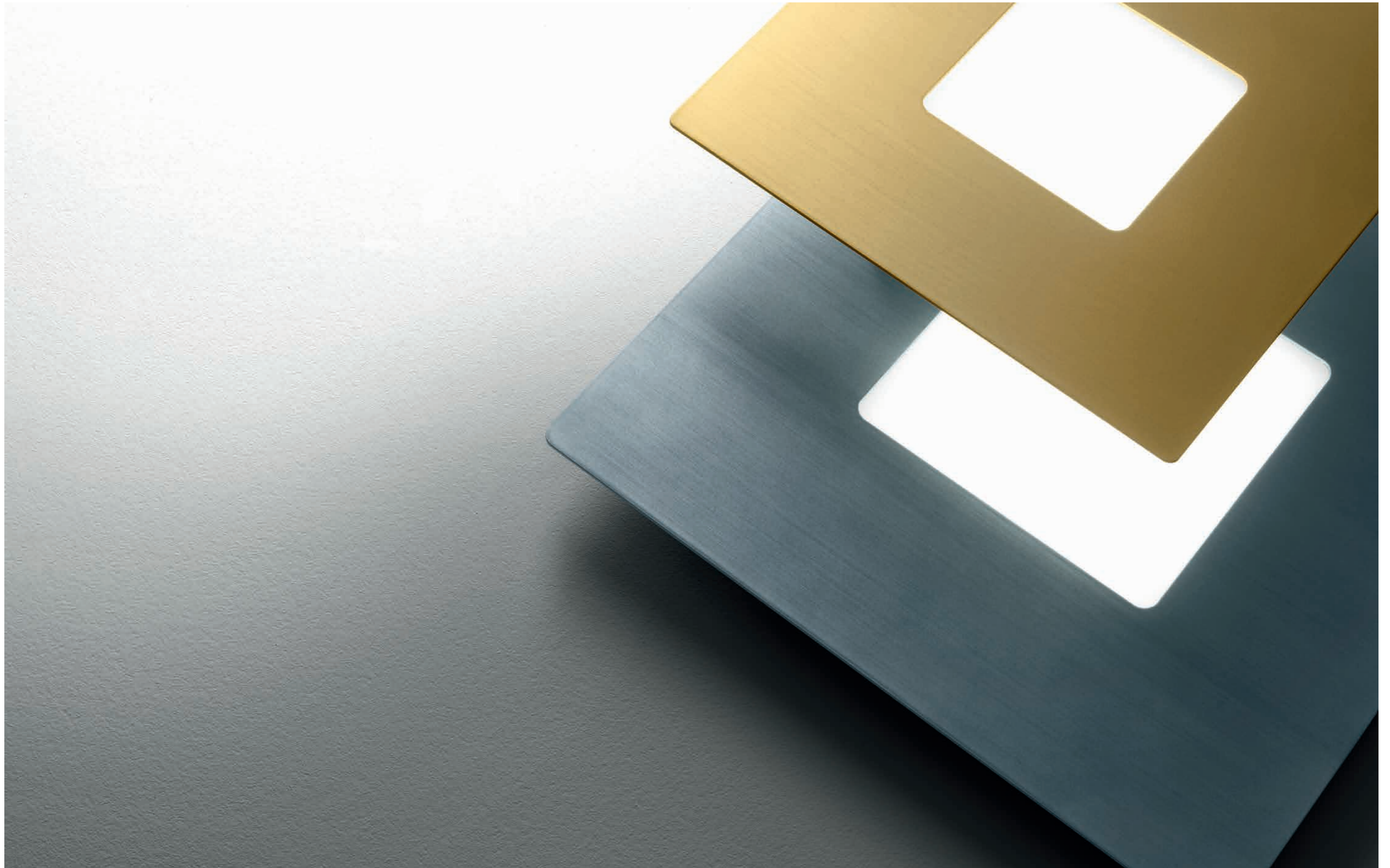

L'essenzialità con cui è disegnato Bilde lo rende adatto anche agli ambienti più eleganti, può essere installato a parete o a soffitto.

Thanks to its simple design, Bilde is suitable for even the most elegant environments and may be wall or ceiling mounted.

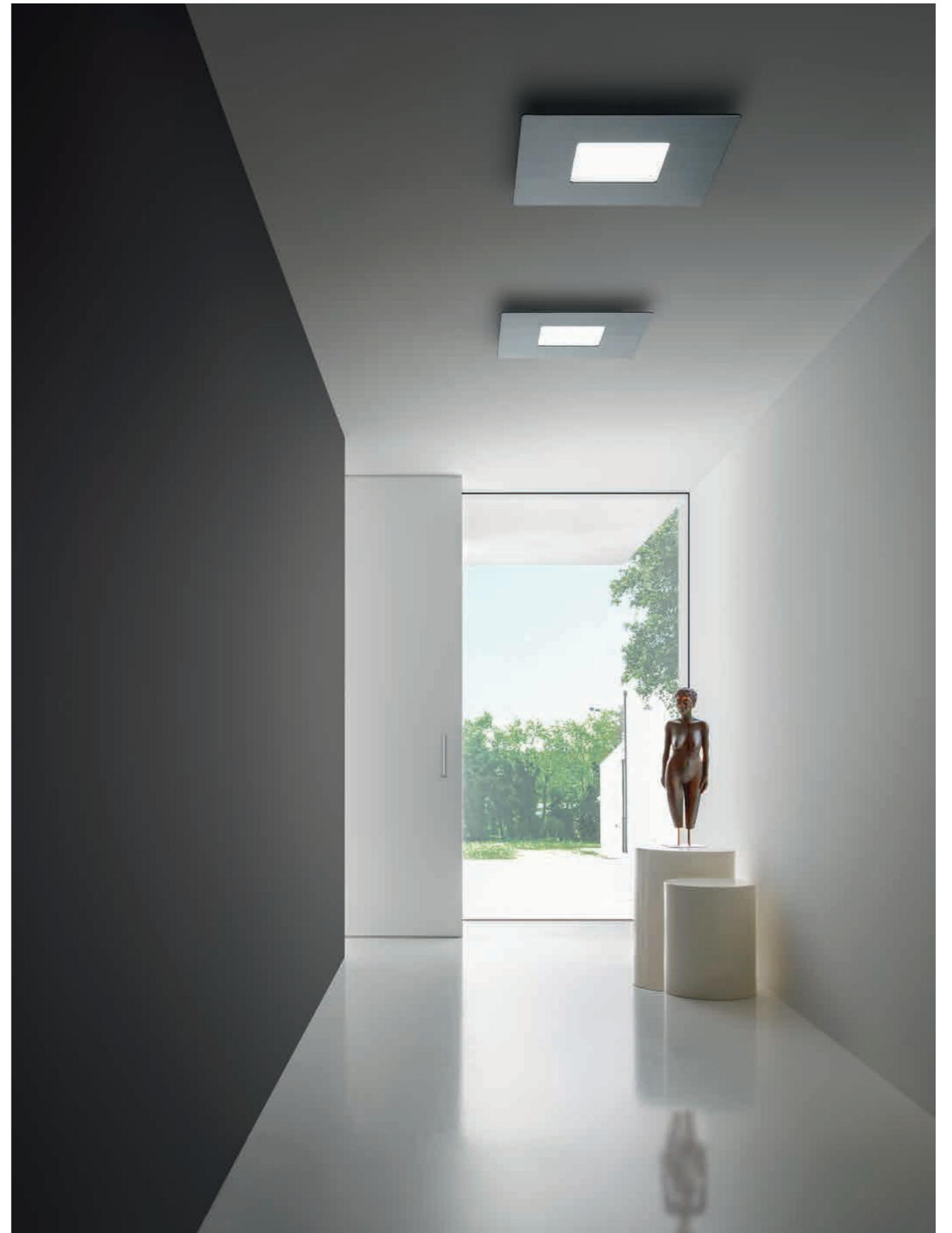

BILDE

PLAFONE

Lampada con struttura in alluminio, diffusore in metacrilato. Disponibile nei colori bianco opaco, piombo opaco ed oro opaco. Sorgente luminosa LED dimmerabile. Illuminazione diretta.

Lamp with aluminium structure and metacrylate diffuser. Available in matt white, matt lead and matt gold. Dimmable LED light source. Direct illumination.

Dimmer compatibile disponibile a pag. 240.

Compatible dimmer available on page 240.

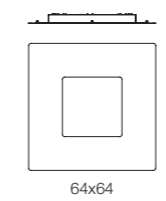

BILDE PL

1 modulo LED
56W
220/240V
5600lm
3000K - CRI >80
Class A+

Disponibili su richiesta moduli con temperatura 4000K.
4000K temperature modules available on request.

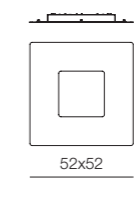

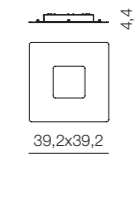

BILDE PM

1 modulo LED
39W
220/240V
3900lm
3000K - CRI >80
Class A+



BILDE PS

1 modulo LED
25W
220/240V
2500lm
3000K - CRI >80
Class A+

FINISHES	CODE	CODE	CODE
 Bianco opaco / Matt white	BILDE PL B	BILDE PM B	BILDE PS B
 Oro opaco / Matt gold	BILDE PL O	BILDE PM O	BILDE PS O
 Piombo opaco / Matt lead	BILDE PL P	BILDE PM P	BILDE PS P

REVIEW
PLAFONE

Citazioni d'arte astratta.
Hints of abstract art.

Una lampada che fa sua l'arte dell'intarsio e ne crea una versione ultra moderna. Review con le sue linee affusolate e le geometrie decise, vuole colpire al cuore degli amanti del design contemporaneo e stupire grazie alla luce diretta a LED incastonata nella struttura in alluminio.

A lamp that makes the art of marquetry its own, creating an ultra-modern version of this traditional skill. Review, with its tapered lines and decisive geometry, is designed for lovers of contemporary design, creating amazement thanks to the direct lighting effect of the LED embedded in the aluminium structure.



Il fitto dialogo tra luce e metallo in Review porta ad avere tre forme a 2 -3 o 4 bracci che, combinati tra loro, danno vita a infinite composizioni.

Review features a close interaction between light and metal and is available in 2, 3 or 4 arm versions that can be combined to create infinite compositions.

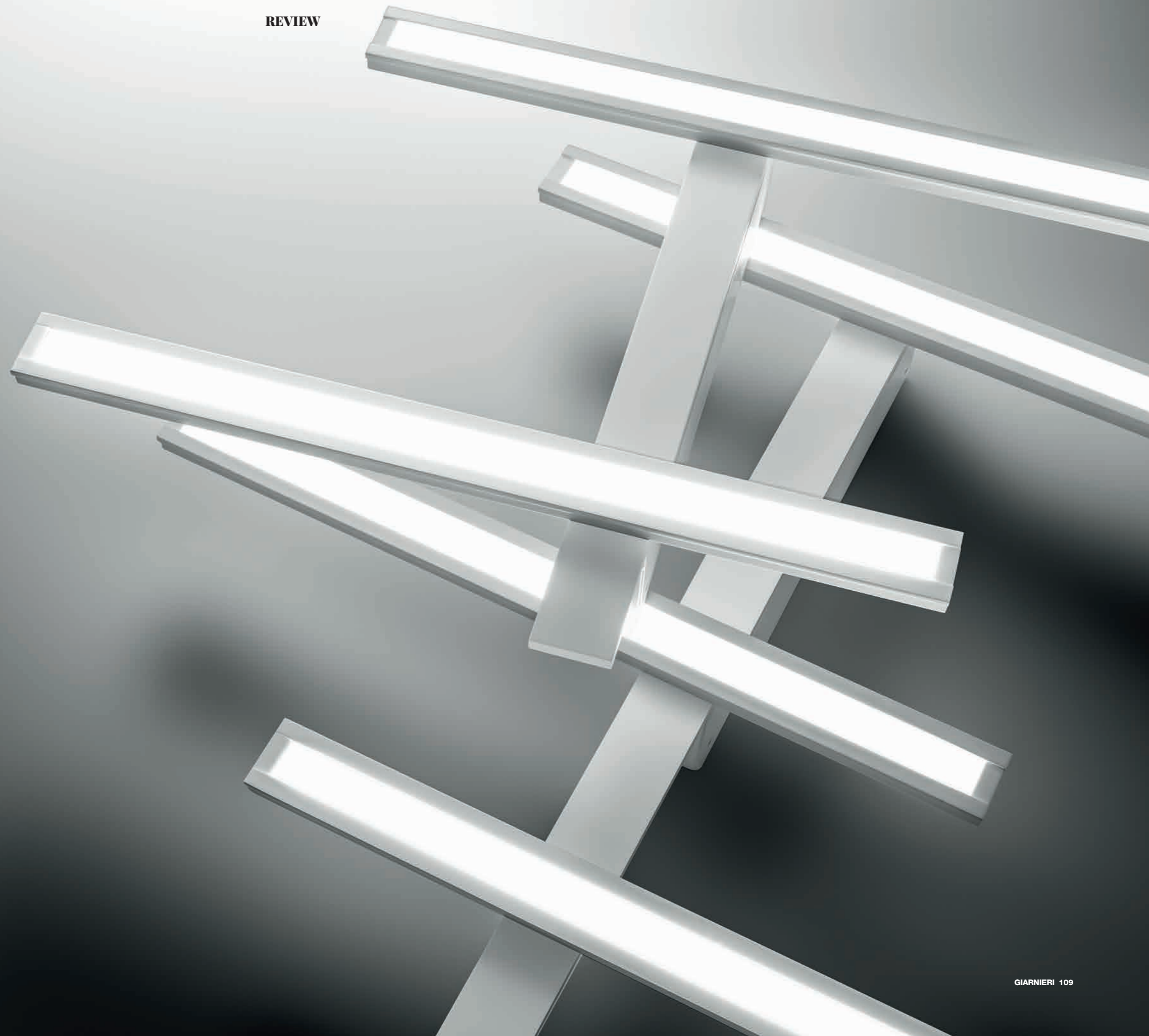

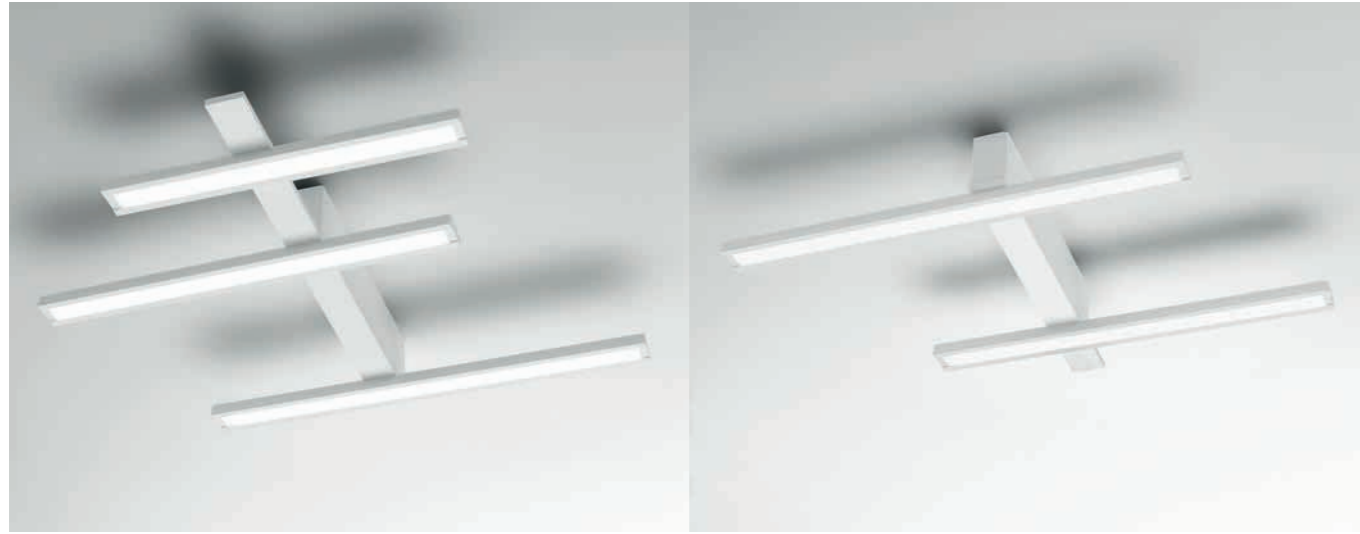

REVIEW PLAFONE

Lampada con struttura in alluminio, diffusore in metacrilato. Disponibile nei colori bianco opaco. Sorgente luminosa LED con alimentatore dimmerabile incluso (Push). Illuminazione indiretta.

Lamp with aluminium structure and metacrylate diffuser. Available in matt white. LED light source with dimmable ballast included (Push). Direct illumination.

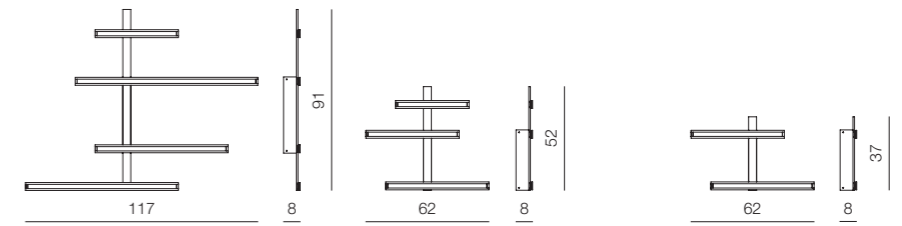

REVIEW PL

4 strip LED
10,4W + 23,4W + 16,9W + 19,5W = 70,2W
220/240V
8424lm
3000K - CRI >80
Class A+

REVIEW PM

3 strip LED
9,1W + 11,7W + 13W = 33,8W
220/240V
4056lm
3000K - CRI >80
Class A+

REVIEW PS

2 strip LED
11,7W + 13W = 24,7W
220/240V
2964lm
3000K - CRI >80
Class A+

Disponibili su richiesta strip con temperatura 4000K.
4000K temperature strips available on request.

FINISHES	CODE	CODE	CODE
<input type="checkbox"/> Bianco opaco / Matt white	REVIEW PL B	REVIEW PM B	REVIEW PS B

RAKE
APPLIQUE
PLAFONE

Modularità per
una luce grafica.
Modularity for
a graphic light.

Rake è una lampada modulare che può essere installata a parete o a soffitto. È stata progettata per dare la massima libertà di espressione a chi la installa. Con la sua struttura slanciata e il suo gioco di geometrie che si intersecano, permette di comporre originali giochi grafici, magari abbinando tra loro più apparecchi, dando sfogo alla fantasia di ognuno.

Rake is a modular lamp designed to be wall or ceiling mounted. It has been designed to give maximum freedom of expression to those who install it. Thanks to its slender structure and interplay of intersecting geometries, anyone can give free rein to their imagination by combining multiple devices to creating unique graphic tricks of the light, for example.





Rake applique oggi si presenta con due nuove versioni a braccio singolo, da 70 e da 95 cm di lunghezza. Anche la composizione a due bracci si rinnova nella forma, con una disposizione più dinamica.

Today, Rake appliqué lamps are available in two new 70 and 95 cm single arm versions. The twin arm version has also been remodelled to lend it a more dynamic layout.





La luce indiretta di Rake si accompagna a cinque colorazioni disponibili per la struttura in alluminio, tra cui i nuovi colori anticato acciaio e oro opaco.

Rake's indirect illumination is available with an aluminium structure in five different colours, including the new aged steel and matt gold versions.





RAKE APPLIQUE

Lampada con struttura in alluminio, diffusore in metacrilato.
Disponibile nei colori bianco opaco, tortora, nero, oro opaco ed anticato acciaio.
Sorgente luminosa LED con alimentatore dimmerabile incluso (Push).
Illuminazione indiretta.

Lamp with aluminium structure and metacrylate diffuser.
Available in matt white, dove grey, matt black, matt gold and antique steel.
LED light source with dimmable ballast included (Push).
Indirect illumination.

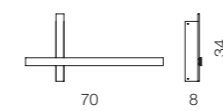

RAKE AXS

1 strip LED
16,9W
220/240V
2028lm
3000K - CRI >80
Class A+

Disponibili su richiesta strip con temperatura 4000K.
4000K temperature strips available on request.

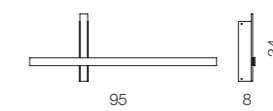



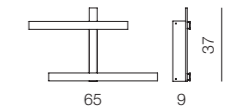

RAKE AS

1 strip LED
23,4W
220/240V
2808lm
3000K - CRI >80
Class A+



RAKE AM

2 strip LED
11,7W + 13W = 24,7W
220/240V
2964lm
3000K - CRI >80
Class A+

FINISHES	CODE	CODE	CODE
 Anticato acciaio / Antique steel	RAKE AXS AA	RAKE AS AA	RAKE AM AA
 Bianco opaco / Matt white	RAKE AXS B	RAKE AS B	RAKE AM B
 Nero opaco / Matt black	RAKE AXS N	RAKE AS N	RAKE AM N
 Oro opaco / Matt gold	RAKE AXS O	RAKE AS O	RAKE AM O
 Tortora / Dove Grey	RAKE AXS T	RAKE AS T	RAKE AM T

RAKE APPLIQUE / PLAFONE

Lampada con struttura in alluminio, diffusore in metacrilato.
Disponibile nei colori bianco opaco, tortora, nero, oro opaco ed anticato acciaio.
Sorgente luminosa LED con alimentatore dimmerabile incluso (Push).
Illuminazione indiretta.

Lamp with aluminium structure and metacrylate diffuser.
Available in matt white, dove grey, matt black, matt gold and antique steel.
LED light source with dimmable ballast included (Push).
Indirect illumination.

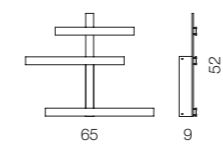

RAKE AL



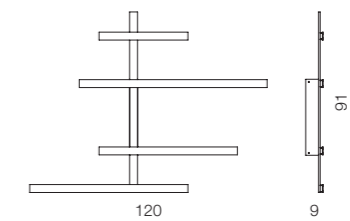

3 strip LED
9,1W + 11,7W + 13W = 33,8W
220/240V
4056lm
3000K - CRI >80
Class A+

Disponibili su richiesta strip con temperatura 4000K.
4000K temperature strips available on request.



RAKE AXL

4 strip LED
10,4W + 23,4W + 16,9W + 19,5W = 70,2W
220/240V
8424lm
3000K - CRI >80
Class A+

FINISHES	CODE	CODE
 Anticato acciaio / Antique steel	RAKE AL AA	RAKE AXL AA
 Bianco opaco / Matt white	RAKE AL B	RAKE AXL B
 Nero opaco / Matt black	RAKE AL N	RAKE AXL N
 Oro opaco / Matt gold	RAKE AL O	RAKE AXL O
 Tortora / Dove Grey	RAKE AL T	RAKE AXL T

SPOKE
PLAFONE
SUSPENSION

Forte e chiaro.
Loud and clear.

Spoke è una lampada che può essere installata a parete o a soffitto, che emana una luce omogenea grazie alle sue forme regolari. Un sottile disco, come i vinili che trasmettevano il suono in modo impeccabile, che proietta attraverso delle svasature centrali una luce conica. Da oggi si è fatto anche quadrato.

Spoke is a lamp designed to be wall or ceiling mounted the produces a homogeneous light thanks to its regular shapes. A thin disc, like the vinyl discs that transmitted sound so perfectly, projects a conical light through central flares. Now also available in a square version.

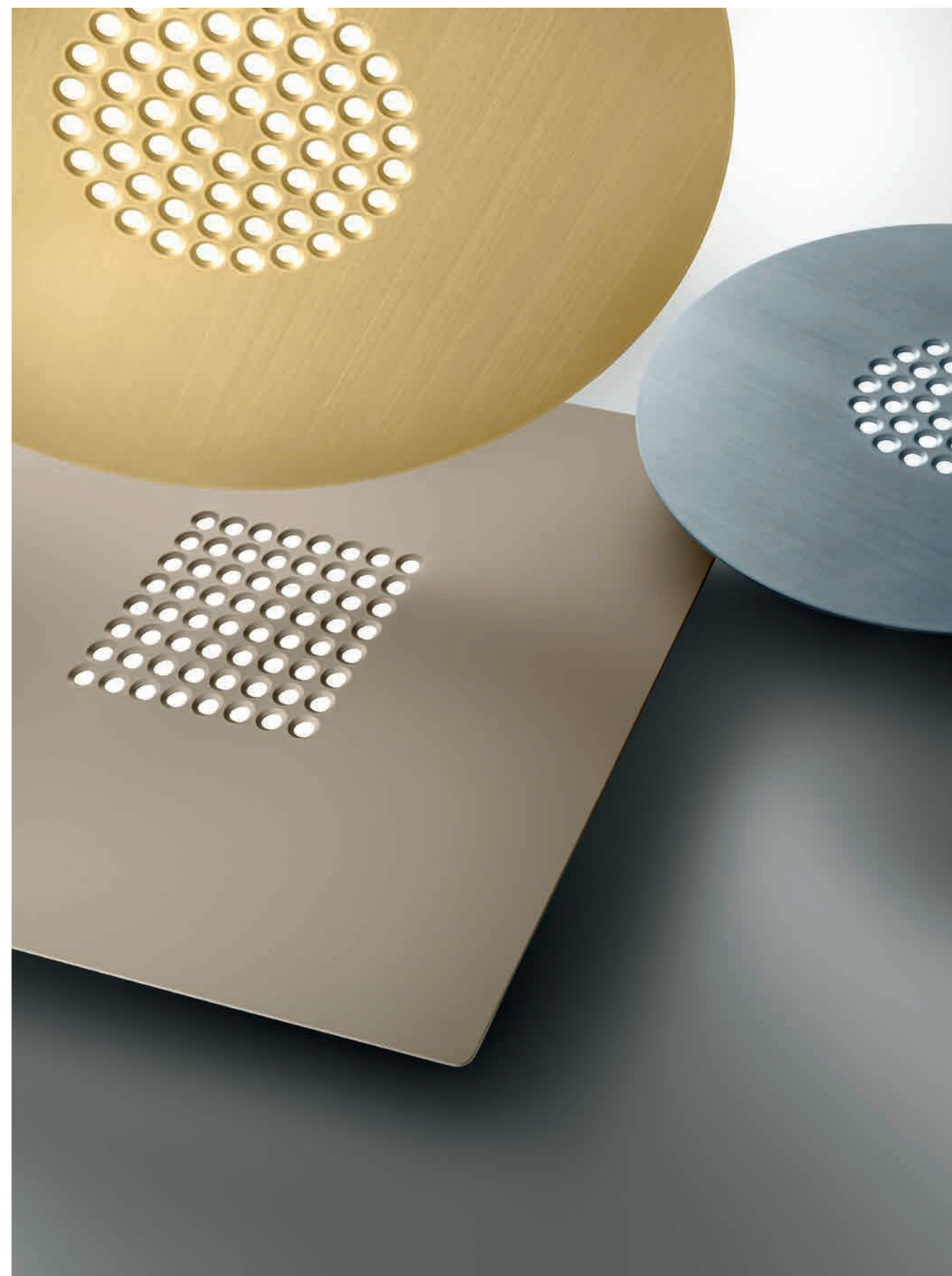



Spoke anche nella versione quadrata a sospensione permette di avere sia luce diretta che luce indiretta, verso l'alto e verso il basso per una migliore distribuzione della luminosità.

Spoke is also available in a square pendant version that produces direct light and indirect light, both upwards and downwards for more evenly distributed illumination.



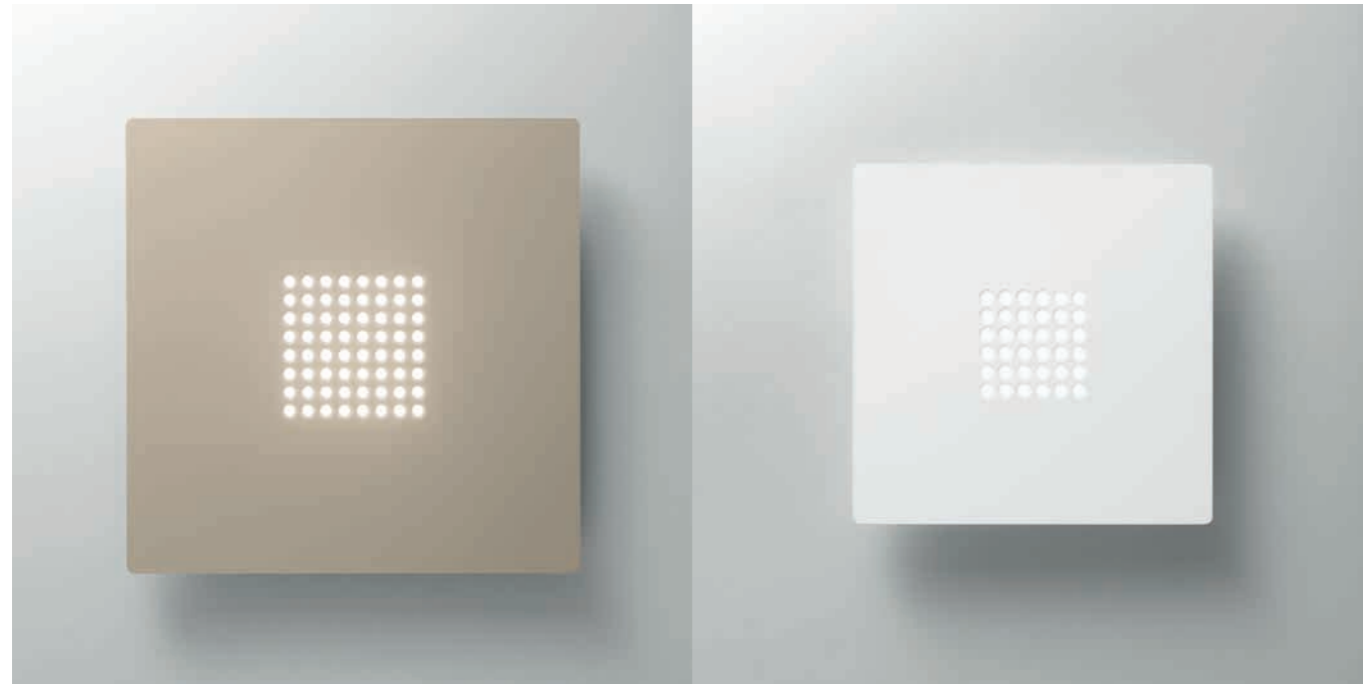

SPOKE Q

PLAFONE

Lampada con struttura in alluminio, diffusore in metacrilato. Disponibile nei colori bianco opaco, tortora, piombo opaco ed oro opaco. Sorgente luminosa LED dimmerabile. Illuminazione diretta.

Lamp with aluminium structure and metacrylate diffuser. Available in matt white, dove grey, matt lead and matt gold. Dimmable LED light source. Direct illumination.

Dimmer compatibile disponibile a pag. 240.

Compatible dimmer available on page 240.

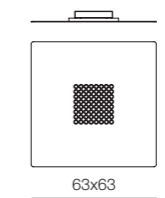



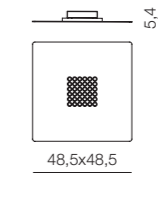

SPOKE Q PL

1 modulo LED
50W
220/240V
5000lm
3000K - CRI >80
Class A+



SPOKE Q PS

1 modulo LED
35W
220/240V
3500lm
3000K - CRI >80
Class A+

FINISHES	CODE	CODE
 Bianco opaco / Matt white	SPOKE Q PL B	SPOKE Q PS B
 Oro opaco / Matt gold	SPOKE Q PL O	SPOKE Q PS O
 Piombo opaco / Matt lead	SPOKE Q PL P	SPOKE Q PS P
 Tortora / Dove Grey	SPOKE Q PL T	SPOKE Q PS T

SPOKE Q

SUSPENSION

Lampada con struttura in alluminio, diffusore in metacrilato. Disponibile nei colori bianco opaco, tortora, piombo opaco ed oro opaco. Sorgente luminosa LED dimmerabile. Illuminazione diretta ed indiretta.

Lamp with aluminium structure and metacrylate diffuser. Available in matt white, dove grey, matt lead and matt gold. Dimmable LED light source. Direct and indirect illumination.

Dimmer compatibile disponibile a pag. 240.

Compatible dimmer available on page 240.

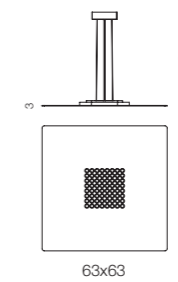



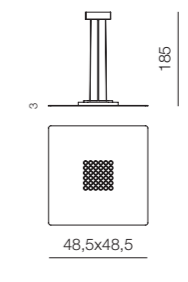

SPOKE Q SL

2 moduli LED
1x50W (down) + 1x12W (up) = 62W
220/240V
6200lm
3000K - CRI >80
Class A+



SPOKE Q SS

2 moduli LED
1x35W (down) + 1x12W (up) = 47W
220/240V
4700lm
3000K - CRI >80
Class A+

FINISHES	CODE	CODE
 Bianco opaco / Matt white	SPOKE Q SL B	SPOKE Q SS B
 Oro opaco / Matt gold	SPOKE Q SL O	SPOKE Q SS O
 Piombo opaco / Matt lead	SPOKE Q SL P	SPOKE Q SS P
 Tortora / Dove Grey	SPOKE Q SL T	SPOKE Q SS T



Spoke è disponibile in una vasta gamma di colori, tra cui piombo opaco, per un effetto completamente scuro, oppure potresti preferire la nuova opzione oro opaco, per un effetto più raffinato.

Spoke is available in a range of colours, including matt lead, for a full dark effect, or you might prefer the new matt gold option, for a more refined effect.



Tra le implementazioni di Spoke, c'è la nuova configurazione dei fori, un dettaglio tecnico che ottimizza la resa luminosa del LED.

Spoke includes innovative features such as the new hole configuration, a technical detail that optimises LED light yield.





SPOKE T PLAFONE

Lampada con struttura in alluminio, diffusore in metacrilato. Disponibile nei colori bianco opaco, tortora, piombo opaco ed oro opaco. Sorgente luminosa LED dimmerabile. Illuminazione diretta.

Lamp with aluminium structure and metacrylate diffuser. Available in matt white, dove grey, matt lead and matt gold. Dimmable LED light source. Direct illumination.

Dimmer compatibile disponibile a pag. 240.

Compatible dimmer available on page 240.

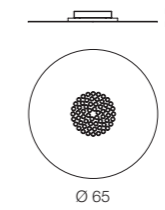

SPOKE T PL

1 modulo LED
50W
220/240V
5000lm
3000K - CRI >80
Class A+

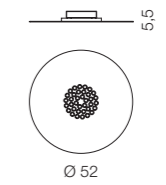

SPOKE T PS

1 modulo LED
35W
220/240V
3500lm
3000K - CRI >80
Class A+

FINISHES	CODE	CODE
Bianco opaco / Matt white	SPOKE T PL B	SPOKE T PS B
Oro opaco / Matt gold	SPOKE T PL O	SPOKE T PS O
Piombo opaco / Matt lead	SPOKE T PL P	SPOKE T PS P
Tortora / Dove Grey	SPOKE T PL T	SPOKE T PS T

SPOKE T SUSPENSION

Lampada con struttura in alluminio, diffusore in metacrilato. Disponibile nei colori bianco opaco, tortora, piombo opaco ed oro opaco. Sorgente luminosa LED dimmerabile. Illuminazione diretta ed indiretta.

Lamp with aluminium structure and metacrylate diffuser. Available in matt white, dove grey, matt lead and matt gold. Dimmable LED light source. Direct and indirect illumination.

Dimmer compatibile disponibile a pag. 240.

Compatible dimmer available on page 240.

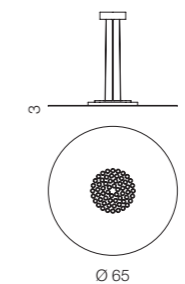

SPOKE T SL

2 moduli LED
1x50W (down) + 1x12W (up) = 62W
220/240V
6200lm
3000K - CRI >80
Class A+

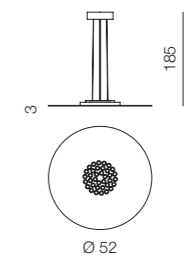

SPOKE T SS

2 moduli LED
1x35W (down) + 1x12W (up) = 47W
220/240V
4700lm
3000K - CRI >80
Class A+

FINISHES	CODE	CODE
Bianco opaco / Matt white	SPOKE T SL B	SPOKE T SS B
Oro opaco / Matt gold	SPOKE T SL O	SPOKE T SS O
Piombo opaco / Matt lead	SPOKE T SL P	SPOKE T SS P
Tortora / Dove Grey	SPOKE T SL T	SPOKE T SS T

PIXEL
PLAFONE

Spazio alla digital light.
Make way for digital light.

Nostalgici dei videogiochi anni ottanta e cultori dello stile non potranno resistere a Pixel e al suo fascino "digitale". Questa lastra di puro metallo, lavorata con incisioni che ricordano lo zoom sui dettagli di un'immagine digitale, risulta un pezzo estremamente di design e gioca con lo spazio, diventando lampada a soffitto o a parete.

Eighties video games enthusiasts and style lovers will not be able to resist Pixel and its "digital" charm. This sheet of pure metal, with incisions that mimic the zoom on the details of a digital image, is a high-design element that can be used to play with space and be installed as either a ceiling or wall lamp.







Pixel è una serie completa, disponibile in tre dimensioni quadrate e due rettangolari, grazie alle quali si possono arredare le pareti e i soffitti di tutte le forme e dimensioni.

Pixel is a complete range of products, available in three square and two rectangular sizes, allowing you to furnish walls and ceilings of all shapes and sizes.





Pixel gioca con gli intrecci, ma rispetta la regola della semplicità che arreda, un must per chi ama le linee semplici ma ben studiate

While Pixel features intricate interplay, it respects the rules of simplicity in terms of decor, a must for anyone who loves simple but well-designed lines.

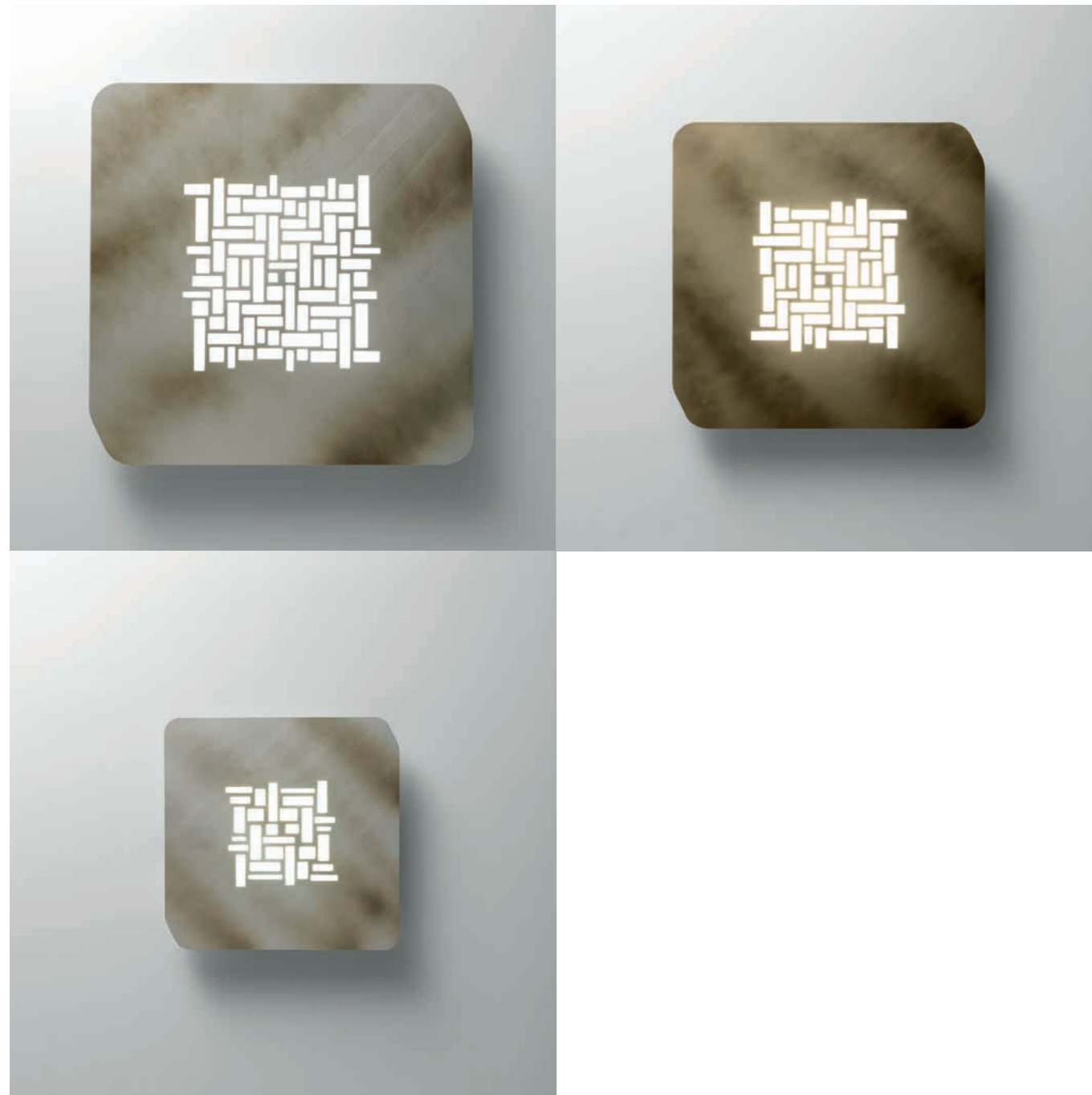

PIXEL PLAFONE

Lampada con struttura in alluminio, diffusore in metacrilato. Disponibile nei colori bianco opaco, tortora, piombo opaco, anticato acciaio ed anticato bronzo. Sorgente luminosa LED dimmerabile. Illuminazione diretta.

Lamp with aluminium structure and metacrylate diffuser. Available in matt white, dove grey, matt lead, antique steel and antique bronze. Dimmable LED light source. Direct illumination.

Dimmer compatibile disponibile a pag. 240.

Compatible dimmer available on page 240.

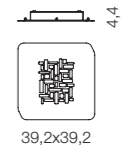
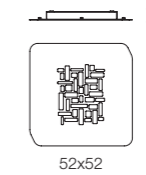
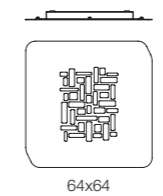

PIXEL PL

1 modulo LED
56W
220/240V
5600lm
3000K - CRI >80
Class A+

Disponibili su richiesta moduli con temperatura 4000K.
4000K temperature modules available on request.

PIXEL PM

1 modulo LED
39W
220/240V
3900lm
3000K - CRI >80
Class A+

PIXEL PS

1 modulo LED
25W
220/240V
2500lm
3000K - CRI >80
Class A+

FINISHES	CODE	CODE	CODE
Anticato acciaio / Antique steel	PIXEL PL AA	PIXEL PM AA	PIXEL PS AA
Anticato bronzo / Antique bronze	PIXEL PL AB	PIXEL PM AB	PIXEL PS AB
Bianco opaco / Matt white	PIXEL PL B	PIXEL PM B	PIXEL PS B
Piombo opaco / Matt lead	PIXEL PL P	PIXEL PM P	PIXEL PS P
Tortora / Dove Grey	PIXEL PL T	PIXEL PM T	PIXEL PS T

PIXEL R PLAFONE

Lampada con struttura in alluminio, diffusore in metacrilato. Disponibile nei colori bianco opaco, tortora, piombo opaco, anticato acciaio ed anticato bronzo. Sorgente luminosa LED dimmerabile. Illuminazione diretta.

Lamp with aluminium structure and metacrylate diffuser. Available in matt white, dove grey, matt lead, antique steel and antique bronze. Dimmable LED light source. Direct illumination.

Dimmer compatibile disponibile a pag. 240.

Compatible dimmer available on page 240.

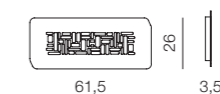
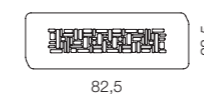

PIXEL R PM

4 moduli LED
4x15W = 60W
220/240V
6000lm
3000K - CRI >80
Class A+

Disponibili su richiesta moduli con temperatura 4000K.
4000K temperature modules available on request.

PIXEL R PS

3 moduli LED
3x15W = 45W
220/240V
4500lm
3000K - CRI >80
Class A+

FINISHES	CODE	CODE
Anticato acciaio / Antique steel	PIXEL R PM AA	PIXEL R PS AA
Anticato bronzo / Antique bronze	PIXEL R PM AB	PIXEL R PS AB
Bianco opaco / Matt white	PIXEL R PM B	PIXEL R PS B
Piombo opaco / Matt lead	PIXEL R PM P	PIXEL R PS P
Tortora / Dove Grey	PIXEL R PM T	PIXEL R PS T

SURF
PLAFONE
SUSPENSION

Il re delle onde.
The king of the waves.

Un oggetto d'arredamento dal design ultra minimal e che per questo colpisce con la sua bellezza semplice ma d'effetto. Questa lastra in alluminio richiama nelle forme le tavole da surf e da vita ad una lama di luce centrale. Disponibile sia a soffitto che in sospensione.

A piece of furniture featuring an ultra-minimal design that makes an impression thanks to its simple but effective beauty. The aluminium sheet recalls the form of a surfboard and gives life to a central blade of light. Available in both ceiling and pendant versions.





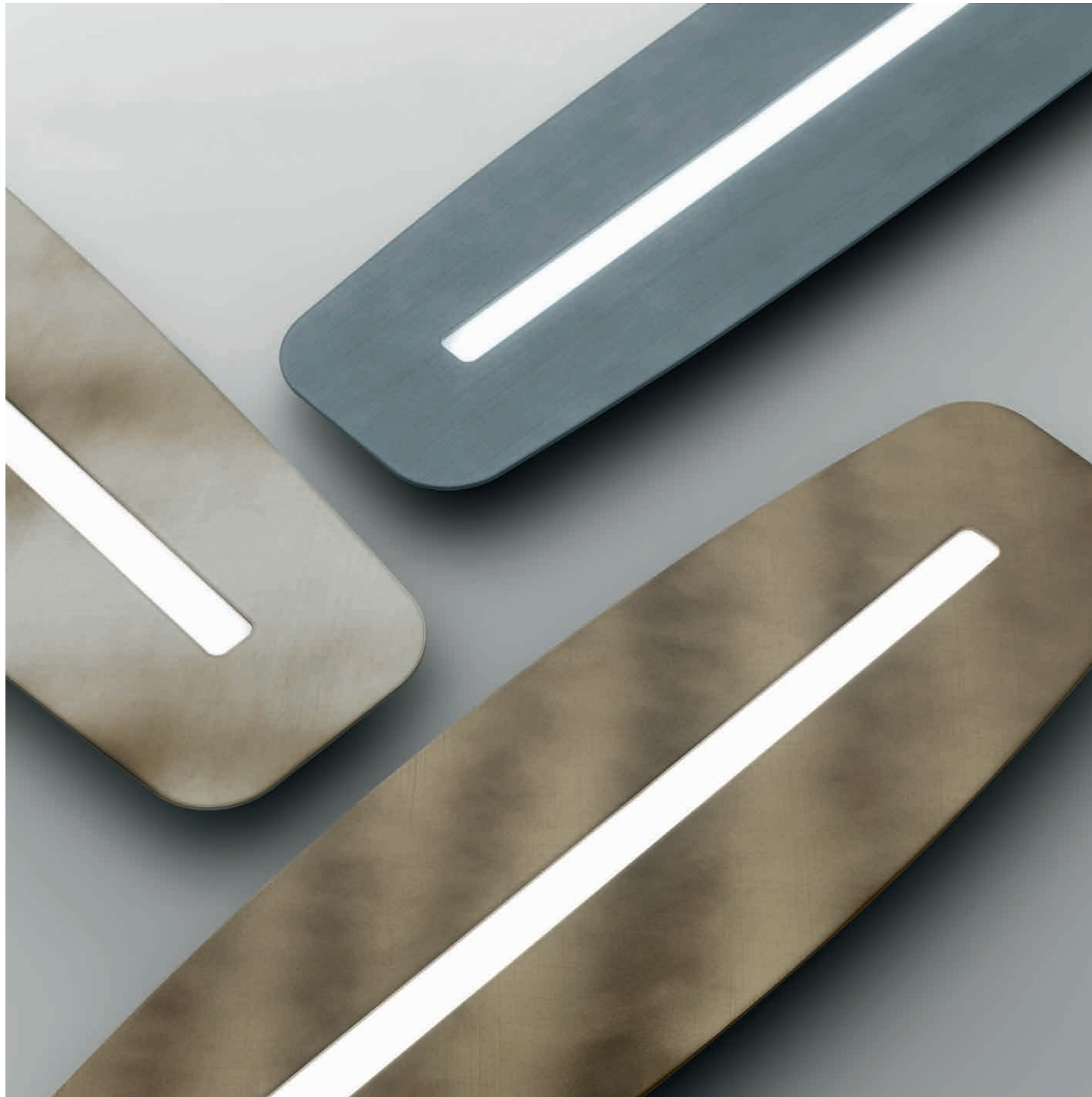

Cavalca l'onda del design, in 5 colorazioni trendy e in 5 modelli: tre a soffitto da 74, 102 e 130 cm di lunghezza e due a sospensione, da 102 e 130 cm di lunghezza.

Catch the design wave in 5 trendy colours and in 5 different models: three ceiling mounted versions in lengths of 74, 102 and 130 cm long, and two pendant versions in lengths of 102 and 130 cm.

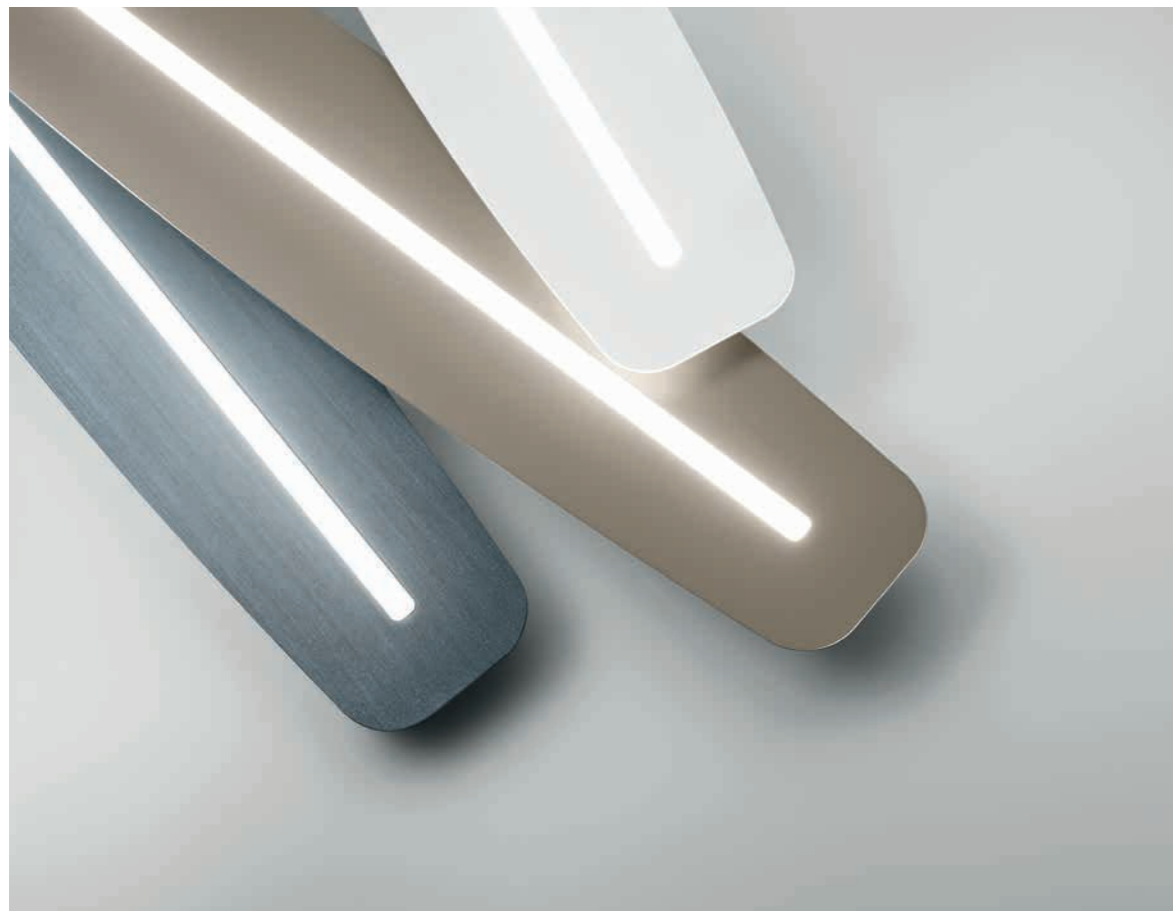

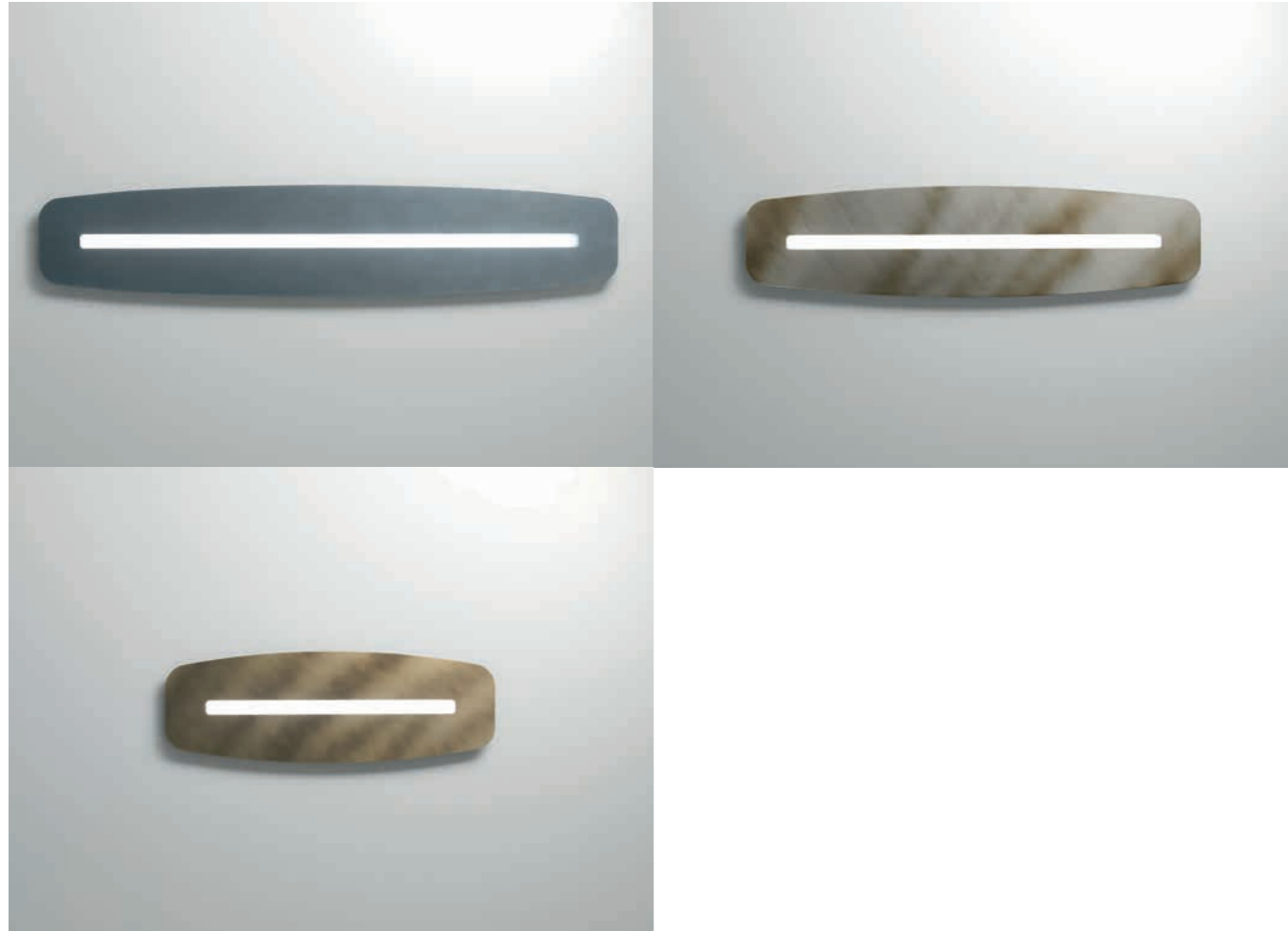

SURF PLAFONE

Lampada con struttura in alluminio, diffusore in metacrilato. Disponibile nei colori bianco opaco, tortora, piombo opaco, anticato acciaio ed anticato bronzo. Sorgente luminosa LED dimmerabile. Illuminazione diretta.

Lamp with aluminium structure and metacrylate diffuser. Available in matt white, dove grey, matt lead, antique steel and antique bronze. Dimmable LED light source. Direct illumination.

Dimmer compatibile disponibile a pag. 240.

Compatible dimmer available on page 240.



SURF PL

4 moduli LED
4x13W = 52W
220/240V
5200lm
3000K - CRI >80
Class A+

Disponibili su richiesta moduli con temperatura 2700K o 4000K.
2700K or 4000K temperature modules available on request.

SURF PM

3 moduli LED
3x13W = 39W
220/240V
3900lm
3000K - CRI >80
Class A+

SURF PS

2 moduli LED
2x13W = 26W
220/240V
2600lm
3000K - CRI >80
Class A+

FINISHES	CODE	CODE	CODE
■ Anticato acciaio / Antique steel	SURF PL AA	SURF PM AA	SURF PS AA
■ Anticato bronzo / Antique bronze	SURF PL AB	SURF PM AB	SURF PS AB
□ Bianco opaco / Matt white	SURF PL B	SURF PM B	SURF PS B
■ Piombo opaco / Matt lead	SURF PL P	SURF PM P	SURF PS P
■ Tortora / Dove Grey	SURF PL T	SURF PM T	SURF PS T

SURF SUSPENSION

Lampada con struttura in alluminio, diffusore in metacrilato. Disponibile nei colori bianco opaco, tortora, piombo opaco, anticato acciaio ed anticato bronzo. Sorgente luminosa LED dimmerabile. Illuminazione diretta ed indiretta.

Lamp with aluminium structure and metacrylate diffuser. Available in matt white, dove grey, matt lead, antique steel and antique bronze. Dimmable LED light source. Direct and indirect illumination.

Dimmer compatibile disponibile a pag. 240.

Compatible dimmer available on page 240.

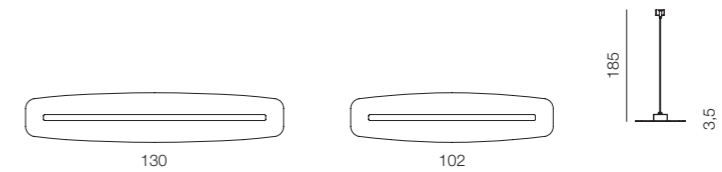

SURF SL

5 moduli LED
4x13W (down) + 1x13W (up) = 65W
220/240V
6500lm
3000K - CRI >80
Class A+

Disponibili su richiesta moduli con temperatura 2700K o 4000K.
2700K or 4000K temperature modules available on request.

SURF SM

4 moduli LED
3x13W (down) + 1x13W (up) = 52W
220/240V
5200lm
3000K - CRI >80
Class A+

FINISHES	CODE	CODE
■ Anticato acciaio / Antique steel	SURF SL AA	SURF SM AA
■ Anticato bronzo / Antique bronze	SURF SL AB	SURF SM AB
□ Bianco opaco / Matt white	SURF SL B	SURF SM B
■ Piombo opaco / Matt lead	SURF SL P	SURF SM P
■ Tortora / Dove Grey	SURF SL T	SURF SM T

MIKADO
APPLIQUE
PLAFONE

Fascino senza tempo.
Timeless charm.

L'arte orientale giapponese è fatta di pochi elementi ben studiati, Mikado si ispira a questo principio per illuminare con fascino gli ambienti di una luce indiretta dai toni morbidi, in contrasto con la sua figura squadrata. Armonia tra le proporzioni e capacità di creare nuove forme, sono le doti di questo apparecchio in alluminio con finiture anticate.

Oriental Japanese art is based on a few, well-chosen elements. Mikado draws its inspiration from this principle and, in contrast to its square shape, illuminates spaces with appealing, indirect soft light tones. Its virtues are the harmony of its proportions and its ability to create new shapes. It is manufactured in aluminium with an aged finish.





A casa come alla SPA, per regalarsi
ogni giorno momenti di relax.

At home or at the SPA, enjoy moments
of relaxation every day.

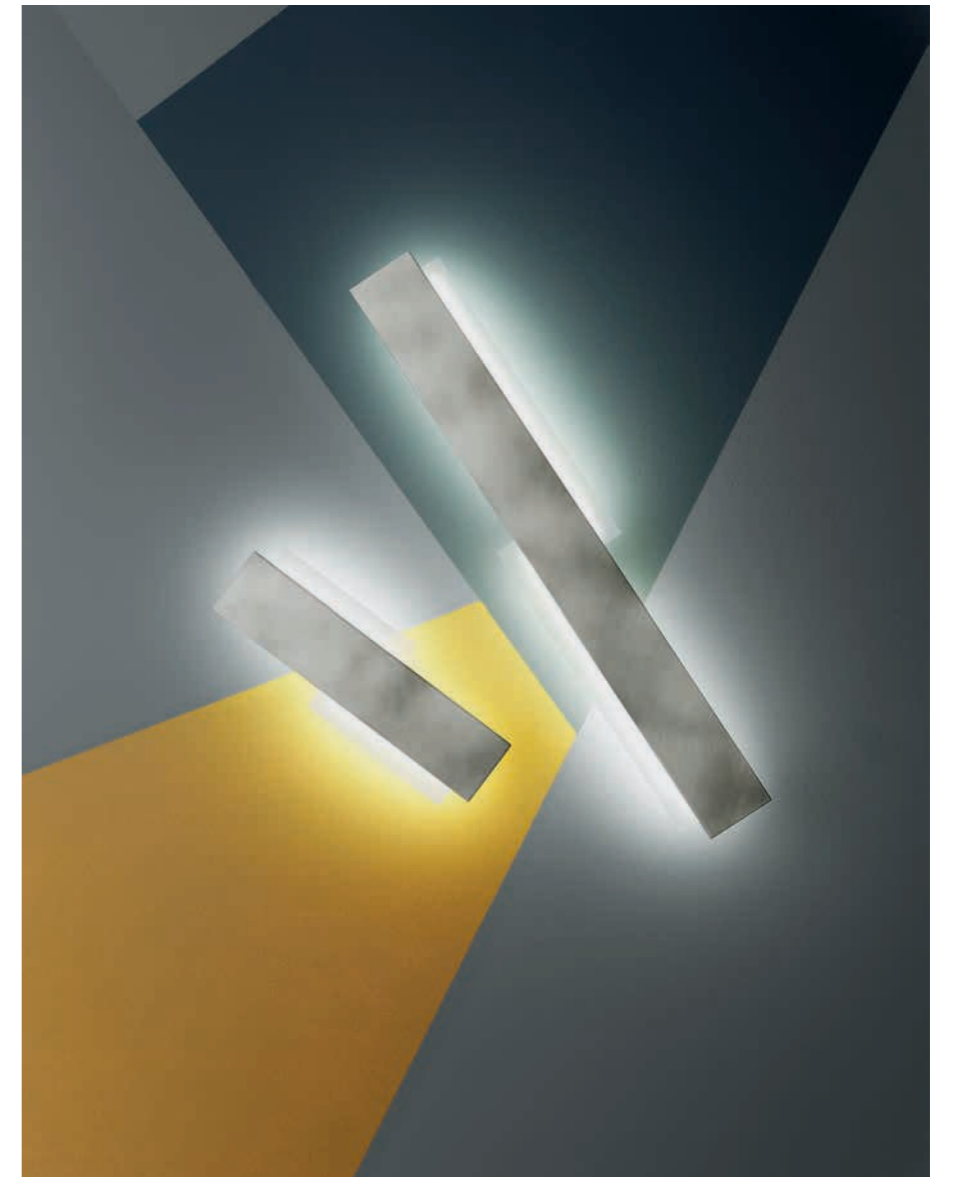





La poesia si rivela dall'armonia che
elementi opposti sanno creare.

The poetry is revealed by the
harmony that opposing elements
can create.



MIKADO

APPLIQUE

Lampada con struttura in alluminio, diffusore in metacrilato.
Disponibile nei colori bianco opaco, tortora, anticato acciaio ed anticato bronzo.
Sorgente luminosa LED dimmerabile.
Illuminazione indiretta.

Lamp with aluminium structure and metacrylate diffuser.
Available in matt white, dove grey, antique steel and antique bronze.
Dimmable LED light source.
Indirect illumination.

Dimmer compatibile disponibile a pag. 240.

Compatible dimmer available on page 240.



MIKADO AL

4 moduli LED
4x15W = 60W
220/240V
6000lm
3000K - CRI >80
Class A+

Disponibili su richiesta moduli con temperatura 4000K.
4000K temperature modules available on request.

MIKADO AS

2 moduli LED
2x15W = 30W
220/240V
3000lm
3000K - CRI >80
Class A+

FINISHES	CODE	CODE
Anticato acciaio / Antique steel	MIKADO AL AA	MIKADO AS AA
Anticato bronzo / Antique bronze	MIKADO AL AB	MIKADO AS AB
Bianco opaco / Matt white	MIKADO AL B	MIKADO AS B
Tortora / Dove Grey	MIKADO AL T	MIKADO AS T

MIKADO

PLAFONE

Lampada con struttura in alluminio, diffusore in metacrilato.
Disponibile nei colori bianco opaco, tortora, anticato acciaio ed anticato bronzo.
Sorgente luminosa LED dimmerabile.
Illuminazione indiretta.

Lamp with aluminium structure and metacrylate diffuser.
Available in matt white, dove grey, antique steel and antique bronze.
Dimmable LED light source.
Indirect illumination.

Dimmer compatibile disponibile a pag. 240.
Per Mikado PL utilizzare 2 dimmer in modalità Master/Slave.

Compatible dimmer available on page 240.
For Mikado PL use 2 dimmers in Master/Slave mode.

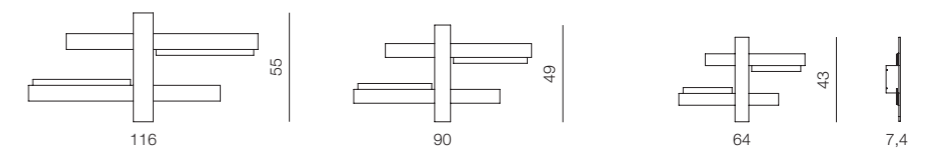

MIKADO PL

8 moduli LED
8x15W = 120W
220/240V
12000lm
3000K - CRI >80
Class A+

Disponibili su richiesta moduli con temperatura 4000K.
4000K temperature modules available on request.

MIKADO PM

6 moduli LED
6x15W = 90W
220/240V
9000lm
3000K - CRI >80
Class A+

MIKADO PS

4 moduli LED
4x15W = 60W
220/240V
6000lm
3000K - CRI >80
Class A+

FINISHES	CODE	CODE	CODE
Anticato acciaio / Antique steel	MIKADO PL AA	MIKADO PM AA	MIKADO PS AA
Anticato bronzo / Antique bronze	MIKADO PL AB	MIKADO PM AB	MIKADO PS AB
Bianco opaco / Matt white	MIKADO PL B	MIKADO PM B	MIKADO PS B
Tortora / Dove Grey	MIKADO PL T	MIKADO PM T	MIKADO PS T

STEP
APPLIQUE
PLAFONE

Twiggy style.

Un disegno geometrico degno dei mitici anni sessanta da cui prende ispirazione anche nei colori pieni ed intensi. Step è un'applique da parete in alluminio, una forma quadrata con angoli stondati che esprime simpatia e giovialità ma che non scherza in fatto di prestazioni illuminotecniche.

A geometric design worthy of the legendary sixties from which it takes inspiration, even in full and intense colours. Step is an aluminium wall light featuring a square shape with rounded corners that expresses a jovial, light-hearted nature, but it's no joke in terms of lighting performance!









Vere e proprie collezioni prêt-à-porter in tanti nuovi colori tra cui anticato acciaio, anticato bronzo, e il nuovissimo oro opaco.

Genuine prêt-à-porter collections in many new colours, including aged steel and bronze, and the brand new matt gold.

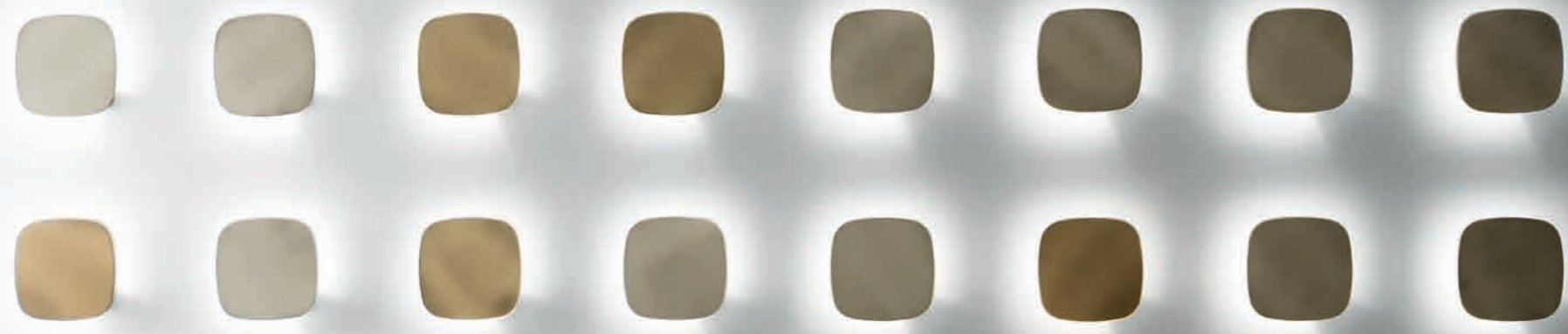



Essenzialità e modularità se ben miscelate sanno dare uno stile unico. Step è disponibile come applique singolo o doppio e si presta a tante combinazioni.

Simplicity and modularity, if mixed correctly, can produce a unique style. Step is available as a single or double wall light and lends itself to a variety of combinations.

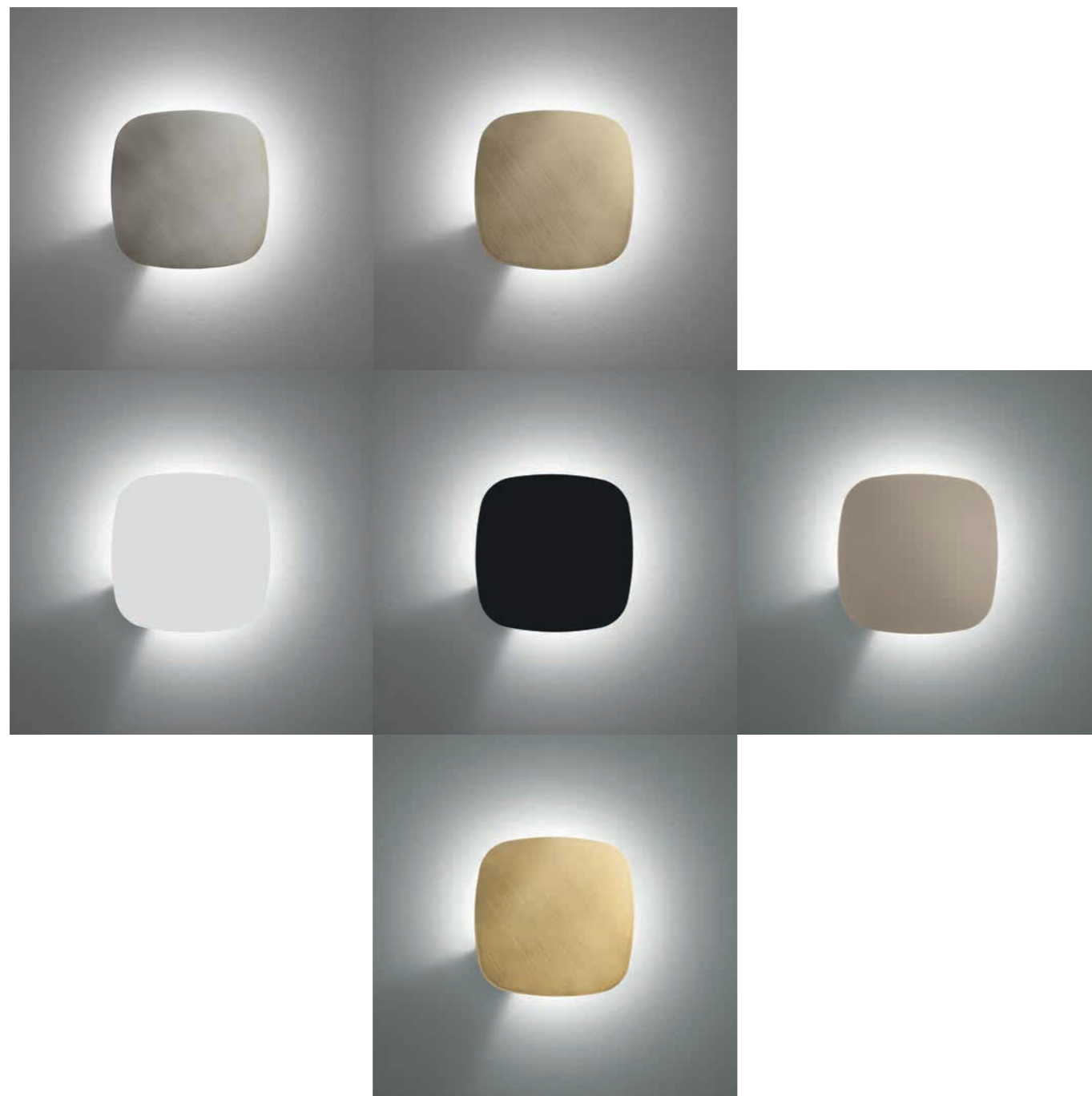

STEP APPLIQUE

Lampada con struttura in alluminio, diffusore in metacrilato.
Disponibile nei colori bianco opaco, tortora, nero opaco, oro opaco, anticato acciaio ed anticato bronzo.
Sorgente luminosa COB LED dimmerabile. Illuminazione indiretta.

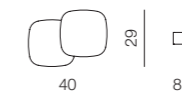

Lamp with aluminium structure and metacrylate diffuser.
Available in matt white, dove grey, lead, matt gold, antique steel and antique bronze.
Dimmable COB LED light source.
Indirect illumination.

Dimmer compatibile
disponibile a pag. 240.

Compatible dimmer
available on page 240.







STEP AL

2 COB LED
2x20W = 40W
220/240V
3600lm
3000K - CRI >80
Class A+

STEP AS

1 COB LED
20W
220/240V
1800lm
3000K - CRI >80
Class A+

Disponibili su richiesta moduli con temperatura 2700K o 4000K.
2700K or 4000K temperature modules available on request.

FINISHES	CODE	CODE
 Anticato acciaio / Antique steel	STEP AL AA	STEP AS AA
 Anticato bronzo / Antique bronze	STEP AL AB	STEP AS AB
 Bianco opaco / Matt white	STEP AL B	STEP AS B
 Nero opaco / Matt black	STEP AL N	STEP AS N
 Oro opaco / Matt gold	STEP AL O	STEP AS O
 Tortora / Dove Grey	STEP AL T	STEP AS T

STEP PLAFONE

Lampada con struttura in alluminio, diffusore in metacrilato.
Disponibile nei colori bianco opaco, tortora, nero opaco, oro opaco, anticato acciaio ed anticato bronzo.
Sorgente luminosa COB LED dimmerabile. Illuminazione indiretta.

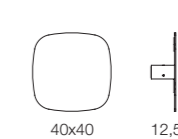

Lamp with aluminium structure and metacrylate diffuser.
Available in matt white, dove grey, lead, matt gold, antique steel and antique bronze.
Dimmable COB LED light source.
Indirect illumination.

Dimmer compatibile
disponibile a pag. 240.

Compatible dimmer
available on page 240.







STEP PM

3 COB LED
3x20W = 60W
220/240V
5400lm
3000K - CRI >80
Class A+

STEP PS

3 COB LED
3x15W = 45W
220/240V
4050lm
3000K - CRI >80
Class A+

Disponibili su richiesta moduli con temperatura 2700K o 4000K.
2700K or 4000K temperature modules available on request.

FINISHES	CODE	CODE
 Anticato acciaio / Antique steel	STEP PM AA	STEP PS AA
 Anticato bronzo / Antique bronze	STEP PM AB	STEP PS AB
 Bianco opaco / Matt white	STEP PM B	STEP PS B
 Nero opaco / Matt black	STEP PM N	STEP PS N
 Oro opaco / Matt gold	STEP PM O	STEP PS O
 Tortora / Dove Grey	STEP PM T	STEP PS T

BLOB
APPLIQUE
PLAFONE

La forma della luce.
The shape of light.

Per chi non sa stare alle regole e ama rompere gli schemi, per chi sceglie sempre un'alternativa alle strade comuni, a tutti voi Blob non farà paura, anzi, questa lampada vi farà innamorare con la sua forma anticonformista. Blob illumina e decora con originalità nelle versioni applique per parete o plafoniera per soffitto.

Blob, with its non-conformist design, is the lamp for anyone who hates rules and loves to break the mould, or prefers to take the "path less travelled". Blob, which is available in ceiling and wall-mounted versions, represents a striking and truly original lighting solution.





Lo spirito innovativo e fuori dagli schemi che rappresenta Blob si manifesta anche nella versione a doppia sorgente luminosa.

Blob's innovative and unconventional spirit that Blob is also apparent in the dual light source version.





Blob a parete o a soffitto è disponibile sia in versione total white, sia con accenti colorati, nelle tinte nero oppure tortora.

Blob wall and ceiling mounted versions are available in total white, with coloured accents, black or taupe.



BLOB

APPLIQUE / PLAFONE

Lampada con struttura in alluminio, diffusore in metacrilato. Disponibile nei colori bianco opaco, nero opaco e tortora. Sorgente luminosa LED dimmerabile. Illuminazione indiretta.

Lamp with aluminium structure and metacrylate diffuser. Available in matt white, matt black and dove grey. Dimmable LED light source. Indirect illumination.

Dimmer compatibile disponibile a pag. 240.

Compatible dimmer available on page 240.

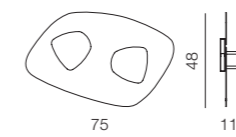

BLOB PL

2 moduli LED
2x23W = 46W
220/240V
4600lm
3000K - CRI >80
Class A+

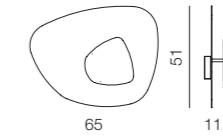

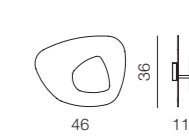

BLOB PS

1 modulo LED
38W
220/240V
3800lm
3000K - CRI >80
Class A+



BLOB A

1 modulo LED
23W
220/240V
2300lm
3000K - CRI >80
Class A+

FINISHES	CODE	CODE	CODE
 Bianco opaco / Matt white	BLOB PL B	BLOB PS B	BLOB A B
 Nero opaco / Matt black	BLOB PL N	BLOB PS N	BLOB A N
 Tortora / Dove Grey	BLOB PL T	BLOB PS T	BLOB A T

ORIONE

Design: BMB progetti

Il cielo in una stanza.
Let the heavens into your room.

Per vivere una magica atmosfera tutti i giorni e non solo la notte dei desideri, basta scegliere Orione. L'appliche a luce indiretta che ti permette di illuminare l'ambiente con la costellazione che crei tu, componendo assieme i corpi luminosi e le loro connessioni.

For a magical experience every day of the year, and not just the Night of the Shooting Stars, choose Orione. The indirect light wall lamp that allows you to illuminate a room with your own constellation, created using a series of luminous bodies and the connections between them.



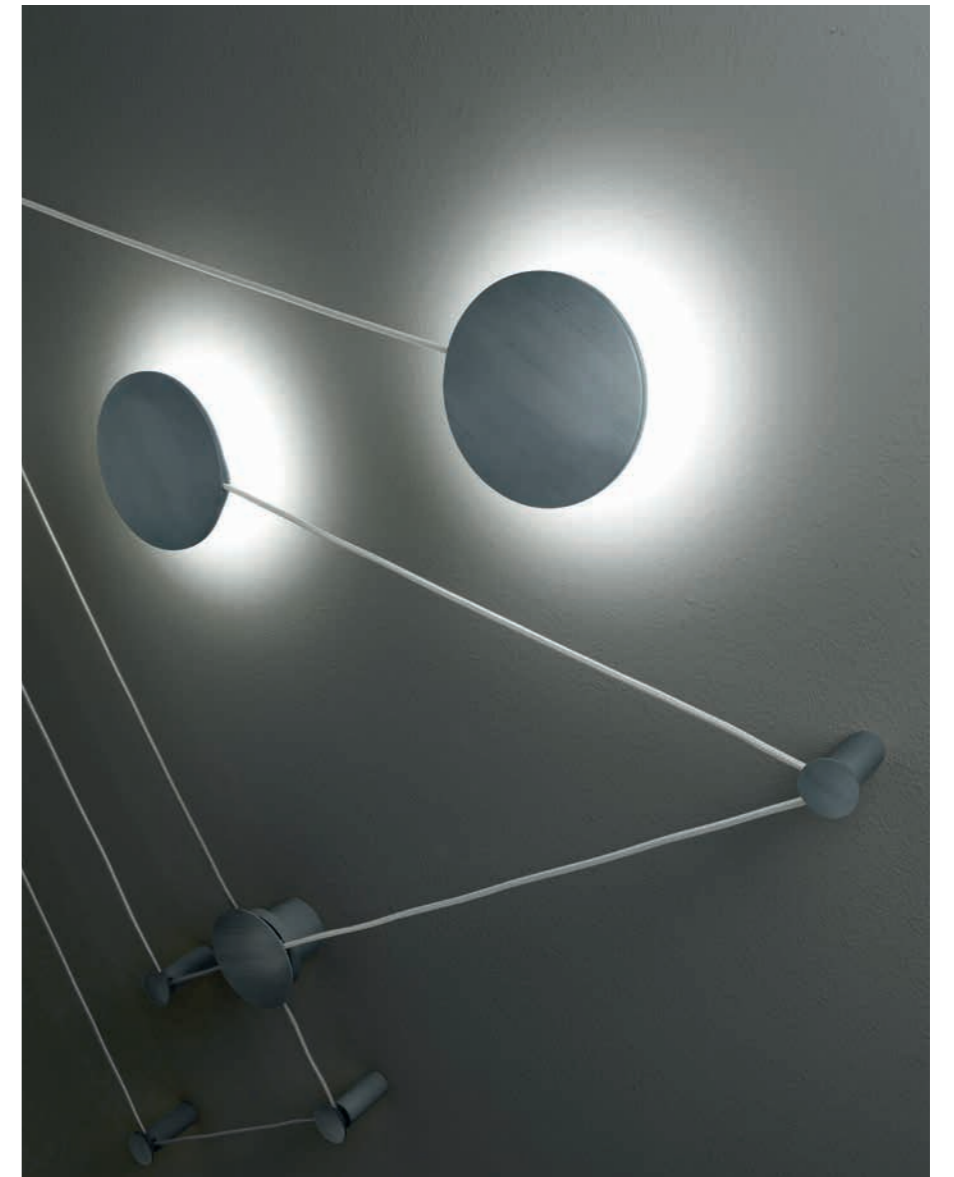

Corpi luminosi e connessioni modulari ti permettono di giocare con le forme e con le posizioni di ogni elemento, così il disegno prende forma.

Luminous bodies and modular connections allow you to play with the shapes and positions of each element to create your own design.



ORIONE

La forma della luce?
La decidi tu!
Orione nasce per permetterti di creare la tua personale composizione luminosa, abbinata tra loro più sorgenti, divertiti a comporre percorsi di luce con i cavi di diverse lunghezze, gli alimentatori e i deviatori messi a tua disposizione.

The shape of light?
You decide!
Orione was born to allow you to create your own luminous composition, combine multiple sources with each other, have fun composing light paths with cables of different lengths, the rosettes and the deviators placed at your disposal.

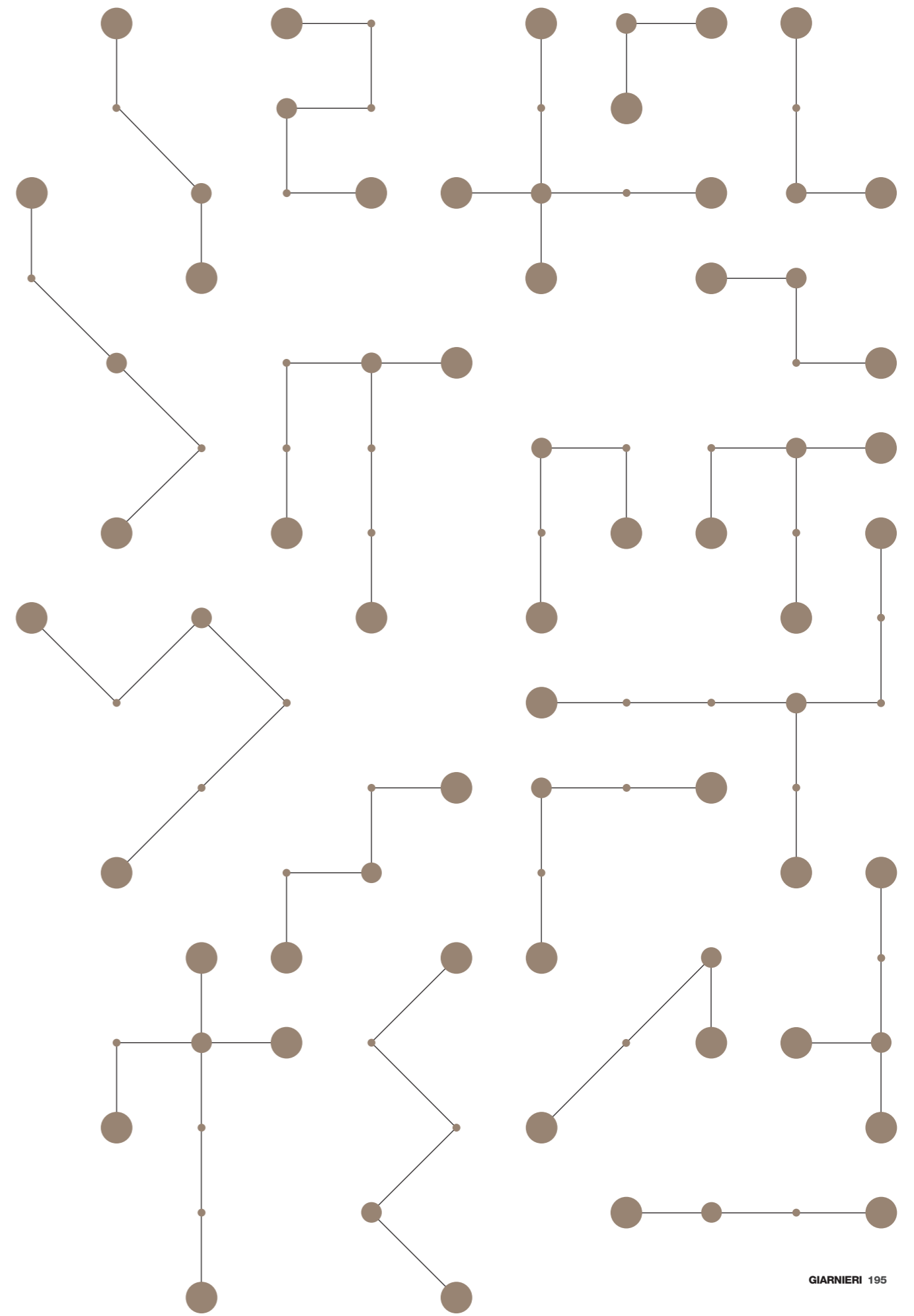

Tessi la tua rete per catturare i sogni e illumina le tue notti con Orione che arreda i tuoi spazi con una soluzione flessibile ai tuoi desideri, oggi anche in versione dorata, con cavo di alimentazione nero.

Weave a net to capture dreams and light up your nights with Orione, furnishing your spaces according to your own desires; today also available in a gold coloured version, with black power cord.



ORIONE

APPLIQUE

Lampada con struttura in alluminio, diffusore in metacrilato.
Disponibile nei seguenti colori: bianco opaco, tortora, piombo opaco con cavo di alimentazione bianco. Oro opaco con cavo di alimentazione nero. Sorgente luminosa LED dimmerabile. Illuminazione indiretta.

Lamp with aluminium structure and metacrylate dif fuser.
Available in following colours: matt white, dove grey, matt lead with white power cord matt. Gold with black power cord. Dimmable LED light source. Indirect illumination.

Dimmer compatibile disponibile a pag. 240.

Compatible dimmer available on page 240.

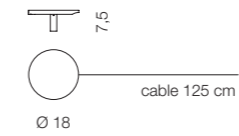

ORIONE A125

1 modulo LED
18W
220/240V
1800lm
3000K - CRI >80
Class A+

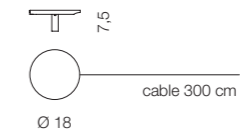

ORIONE A300

1 modulo LED
18W
220/240V
1800lm
3000K - CRI >80
Class A+

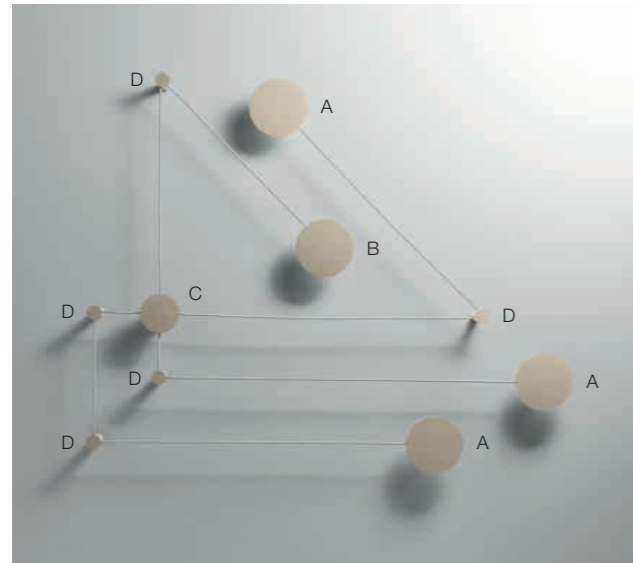

Composizione Orione 4 punti luce.
Orione composition with 4 light points as shown in the sample order.

- A - 3 **ORIONE A300 T**
- B - 1 **ORIONE A125 T**
- C - 1 **ORIONE B T**
- D - 5 **ORIONE D T**

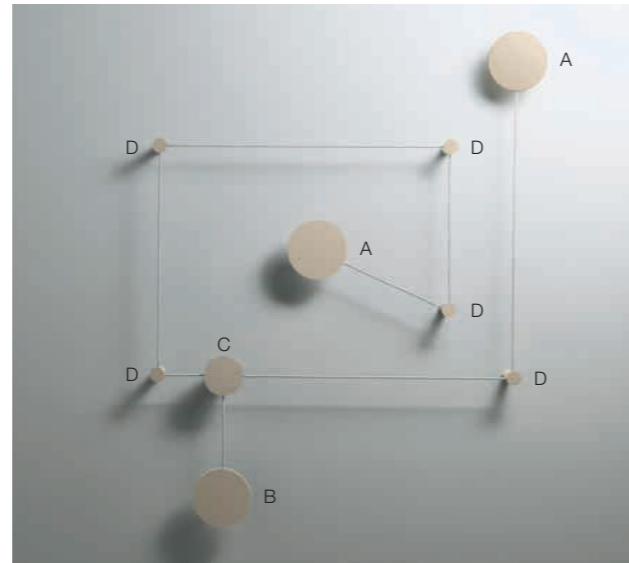

Composizione Orione 3 punti luce.
Orione Composition with 3 light points as shown in the sample order.

- A - 2 **ORIONE A300 T**
- B - 1 **ORIONE A125 T**
- C - 1 **ORIONE B T**
- D - 5 **ORIONE D T**

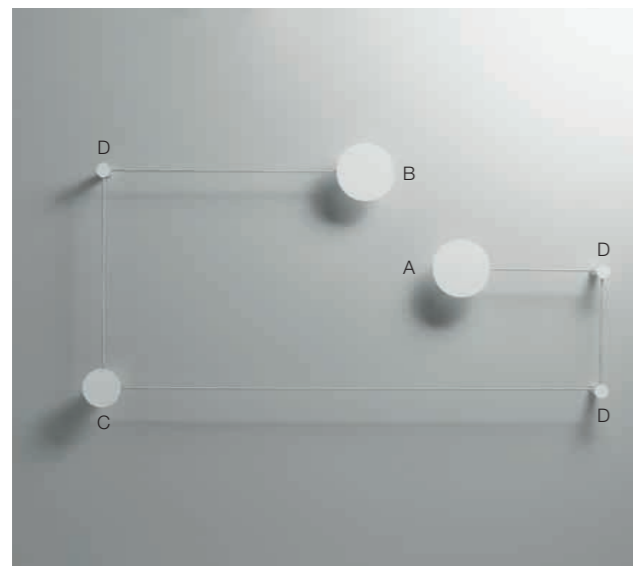

Composizione Orione 2 punti luce.
Orione Composition with 2 light points as shown in the sample order.

- A - 1 **ORIONE A 300 B**
- B - 1 **ORIONE A 125 B**
- C - 1 **ORIONE B B**
- D - 3 **ORIONE D B**

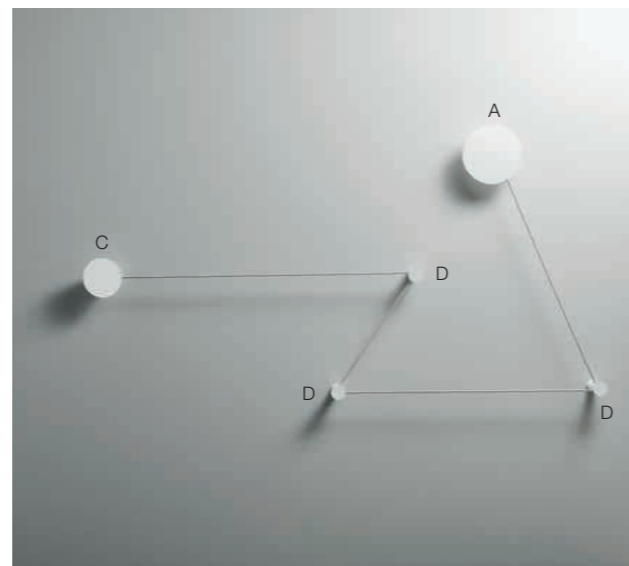

Composizione Orione 1 punto luce.
Orione Composition with 1 light point as shown in the sample order.

- A - 1 **ORIONE A 300 B**
- C - 1 **ORIONE B B**
- D - 3 **ORIONE D B**

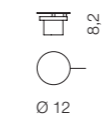

ORIONE B

Rosone di connessione predisposto per l'installazione da 1 a 4 punti luce.

Rosette for connection prepared for installations of 1 to 4 light points.

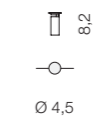

ORIONE D

Tenditore/Deviatore elemento in metallo con la funzione di tenere in tensione il cavo di alimentazione e creare curve per originalissimi giochi di luce e design.

Metal turnbuckle and diverter with voltage functions and curvature of the power cable for creating original light paths.

FINISHES	CODE	CODE
Bianco opaco / Matt white	ORIONE B B	ORIONE D B
Oro opaco / Matt gold	ORIONE B O	ORIONE D O
Piombo opaco / Matt lead	ORIONE B P	ORIONE D P
Tortora / Dove Grey	ORIONE B T	ORIONE D T

PLUG
APPLIQUE

Frizzante al punto giusto.
Just the right amount of sparkle.

Un punto luce d'effetto che piega il metallo al servizio della creatività. Plug stappa la voglia di allegria e modernità. Un'applicque con LED integrato in alluminio pressofuso che esprime con linee semplici e compatte la sua attitudine ad uno stile contemporaneo. Elegante con brio.

A striking spotlight effect that bends metal to the service of creativity. Plug unleashes the desire for joy and modernity. A wall lamp with built-in LED light source in die-cast aluminium that expresses a contemporary style through simple, compact lines. Elegant with brio.





Plug misura 21x16,5 cm ed è proposto in tanti colori di tendenza, ideale per creare varie composizioni, monocromatiche o multicolor.

Plug measures 21x16,5 cm and is available in a range of trendy colours, ideal for creating a variety of monochromatic or multi-coloured compositions.

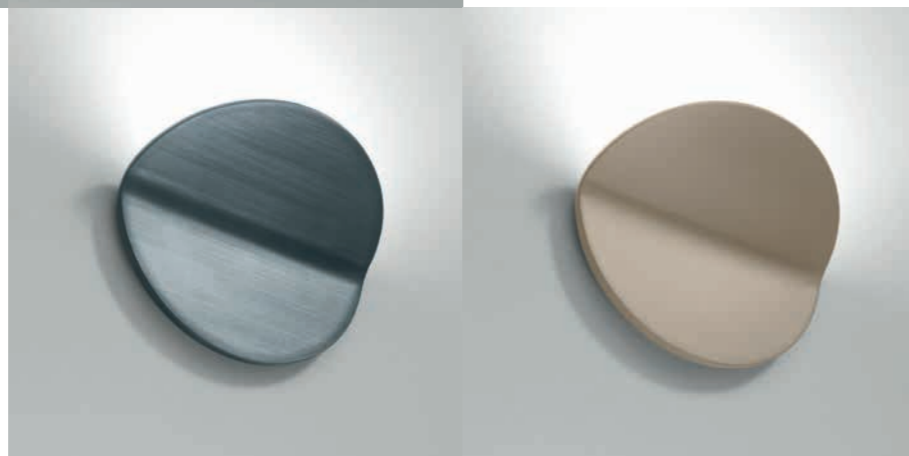
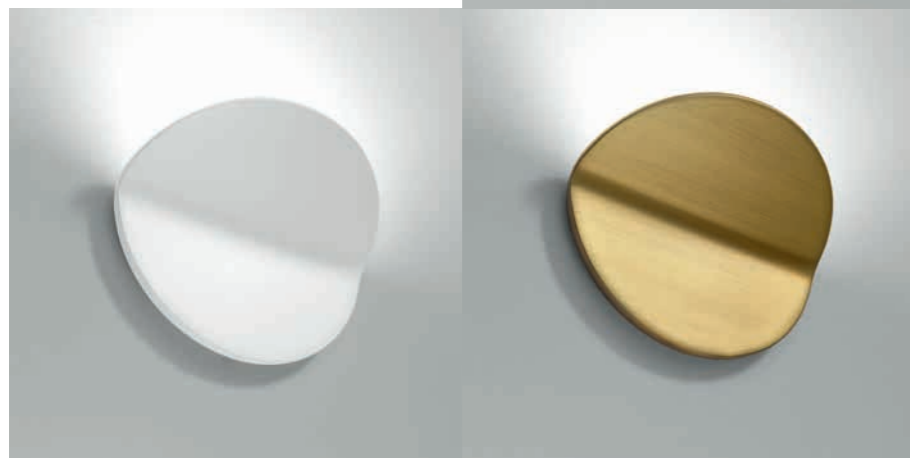
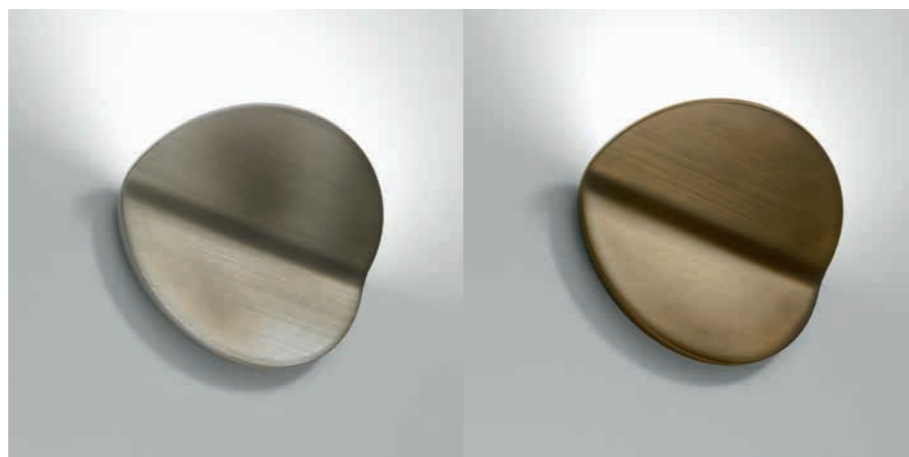

PLUG

APPLIQUE

Lampada con struttura in alluminio pressofuso, diffusore in metacrilato. Disponibile nei colori bianco opaco, tortora, piombo opaco, oro opaco, anticato acciaio ed anticato bronzo. Sorgente luminosa COB LED dimmerabile. Illuminazione indiretta.

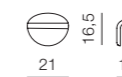

Lamp with die-cast aluminium structure and metacrylate diffuser. Available in matt white, dove grey, matt lead, matt gold, antique steel and antique bronze. Dimmable COB LED light source. Indirect illumination.

Dimmer compatibile disponibile a pag. 240.

Compatible dimmer available on page 240.







PLUG A

1 COB LED
20W
220/240V
1800lm
3000K - CRI >80
Class A+

Disponibili su richiesta moduli con temperatura 2700K o 4000K. 2700K or 4000K temperature modules available on request.

FINISHES

CODE

	Anticato acciaio / Antique steel	PLUG A AA
	Anticato bronzo / Antique bronze	PLUG A AB
	Bianco opaco / Matt white	PLUG A B
	Oro opaco / Matt gold	PLUG A O
	Piombo opaco / Matt lead	PLUG A P
	Tortora / Dove Grey	PLUG A T

WOW
APPLIQUE

Nuove linee di
vertiginosa bellezza.
Dazzlingly
beautiful new lines.

Una bellezza senza tempo rivista in chiave moderna, crea la figura elegante dagli angoli decisi di Wow, una lampada applique con struttura in alluminio compatta e allo stesso tempo leggera, grazie all'equilibrio tra chiaroscuri che creano gli angoli.

The elegant figure and decisive angles of Wow are the result of a timeless beauty re-imagined through a modern lens; this wall lamp features a compact, light aluminium structure, thanks to the balance between light and dark created by the corners.





In Wow il metallo, disponibile in vari colori, gioca con la luce LED a biemissione indiretta e crea un'atmosfera elegante e ricercata.

The metal structure of Wow, which is available in a range of colours, interacts with the indirect bi-emission LED light source to create an elegant and refined atmosphere.





WOW

APPLIQUE

Lampada con struttura in alluminio pressofuso, diffusore in metacrilato. Disponibile nei colori bianco opaco, tortora, piombo ed oro opaco. Sorgente luminosa LED dimmerabile. Illuminazione indiretta.

Lamp with die-cast aluminium structure and metacrylate diffuser. Available in matt white, dove grey, lead and matt gold. Dimmable LED light source. Indirect illumination.

Dimmer compatible disponibile a pag. 240.

Compatible dimmer available on page 240.

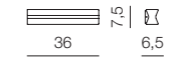

WOW A

2 moduli LED
2x13W = 26W
220/240V
2600lm
3000K - CRI >80
Class A+

Disponibili su richiesta moduli con temperatura 2700K o 4000K. 2700K or 4000K temperature modules available on request.

FINISHES

<input type="checkbox"/>	Bianco opaco / Matt white
<input type="checkbox"/>	Oro opaco / Matt gold
<input type="checkbox"/>	Piombo opaco / Matt lead
<input type="checkbox"/>	Tortora / Dove Grey

CODE

WOW A B

WOW A O

WOW A P

WOW A T

ALLEN
APPLIQUE

Moderna eleganza.
Modern elegance.

Linee pulite e un sapiente gioco tra pieni e vuoti fanno di questa applique in alluminio pressofuso un must dell'arredamento moderno. Allen, come uno scrigno che si apre, rivela la sua anima di luce a LED e le sue linee rigorose acquisiscono un tocco di raffinatezza in più grazie alle finiture bicolore.

Clean lines and clever juxtaposition between solids and voids render this wall lamp in die-cast aluminium an essential element of modern decor. Like opening a treasure chest, Allen reveals the LED light sources at its heart and its rigorous lines acquire an extra touch of refinement thanks to the two-tone finishes.





Allen una lampada a LED a biemissione che crea effetti luminosi scenografici e mette in risalto punti specifici dell'architettura in cui è inserita.

Allen features a bi-emission LED light source that creates spectacular lighting effects and highlights specific points of the architecture into which it is inserted.





ALLEN

APPLIQUE

Lampada con struttura in alluminio estruso, diffusore in metacrilato. Disponibile nei colori bianco opaco/bianco opaco, grigio chiaro/piombo opaco, nero/oro opaco ed oro/antico bronzo. Sorgente luminosa LED dimmerabile. Illuminazione indiretta.

Lamp with extruded aluminium structure and metacrylate diffuser. Available in matt white/matt white, light grey/matt lead, black/matt gold and gold/antique bronze. Dimmable LED light source. Indirect illumination.

Dimmer compatibile disponibile a pag. 240.

Compatible dimmer available on page 240.

FINISHES

	Oro / Antico bronzo Gold / Antique bronze
	Bianco opaco / Bianco opaco Matt white / Matt white
	Nero / Oro opaco Black / Matt gold
	Grigio chiaro / Piombo opaco Light grey / Matt lead

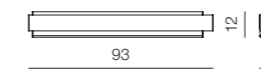

ALLEN AL

6 moduli LED
6x13W = 78W
220/240V
7800lm
3000K - CRI >80
Class A+

Disponibili su richiesta moduli con temperatura 2700K o 4000K.
2700K or 4000K temperature modules available on request.

CODE

ALLEN AL AB

ALLEN AL B

ALLEN AL O

ALLEN AL P

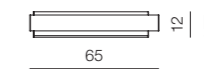

ALLEN AM

4 moduli LED
4x13W = 52W
220/240V
5200lm
3000K - CRI >80
Class A+

CODE

ALLEN AM AB

ALLEN AM B

ALLEN AM O

ALLEN AM P

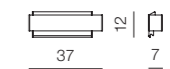

ALLEN AS

2 moduli LED
2x13W = 26W
220/240V
2600lm
3000K - CRI >80
Class A+

CODE

ALLEN AS AB

ALLEN AS B

ALLEN AS O

ALLEN AS P

BABOL
APPLIQUE

Un concentrato
di energia.
A concentration
of energy.

Un concentrato di luce e tecnologia racchiuse in 11 cm. Babol esprime tutto il suo potenziale estetico in pochissimo spazio. Un'applicque con lampadina a LED con illuminazione indiretta in alluminio pressofuso che ricorda quanto anche i piccoli possano essere forti.

A concentration of light and technology enclosed in a space of just 11 cm. Babol expresses its full aesthetic potential despite its limited size. A wall lamp with an indirect LED light source in die-cast aluminium that reminds us how strong even the smallest object can be.





Babol è un vero cubo di luce impreziosito da finiture superficiali, tra cui due tonalità con effetto anticato e il nuovissimo color piombo opaco.

Babol is a cube of light embellished with a choice of surface finishes, including two shades with an aged effect and the brand new matt lead colour.



BABOL

APPLIQUE

Lampada con struttura in alluminio pressofuso, diffusore in metacrilato. Disponibile nei colori bianco opaco, tortora, piombo opaco, oro opaco, anticato acciaio ed anticato bronzo. Sorgente luminosa lampadine Gx53 LED 3000K incluse. Illuminazione indiretta.

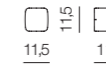

Lamp with die-cast aluminium structure and metacrylate diffuser. Available in matt white, dove grey, matt lead, matt gold, antique steel and antique bronze. Gx53 LED 3000K light source. Bulbs included. Indirect illumination.







BABOL A

2xGx53
2x8W = 16W
220/240V
3000K
Class B / A++

Disponibili su richiesta lampadine con temperatura 4100K.
4100K temperature bulbs available on request.

FINISHES

CODE

	Anticato acciaio / Antique steel	BABOL A AA
	Anticato bronzo / Antique bronze	BABOL A AB
	Bianco opaco / Matt white	BABOL A B
	Oro opaco / Matt gold	BABOL A O
	Piombo opaco / Matt lead	BABOL A P
	Tortora / Dove Grey	BABOL A T

CORBA
APPLIQUE

Raffinate simmetrie. Refined symmetries.

Le figure geometriche classiche arredano con sobrietà ed eleganza. Grazie a Corba, un applique in alluminio pressofuso, si crea nell'ambiente un'atmosfera raccolta dove la luce a biemissione è la protagonista con il suo doppio fascio d'illuminazione.

The classic geometric figures lend sobriety and elegance to any decor. Corba, a die-cast aluminium wall lamp, allows you to create a cosy atmosphere with a dual light beam generated by the bi-emission illumination source.

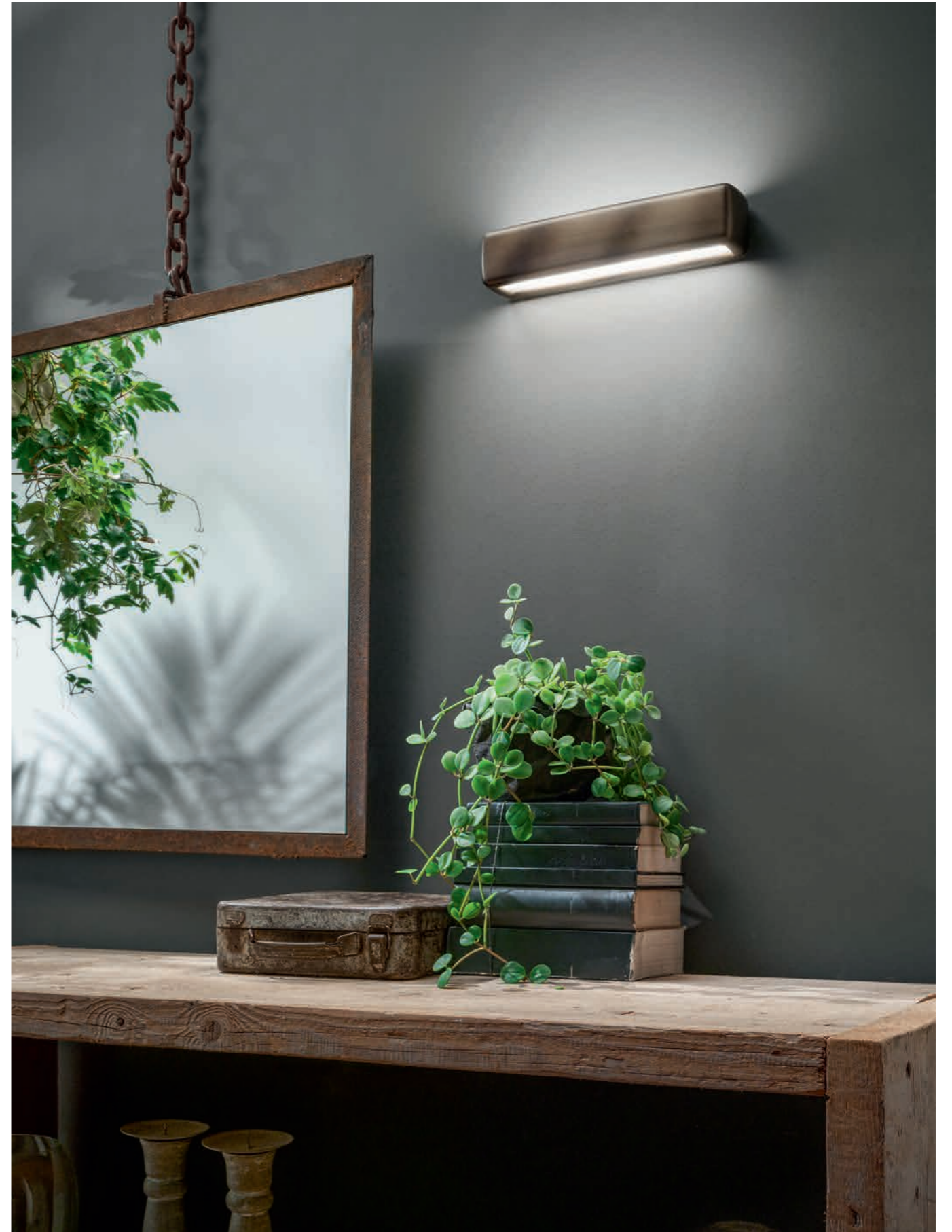

Corba è proposto in tanti colori
differenti, che possono avere effetti
antichi, opachi o satinati.

Corba is offered in a wide range
of colours, and with aged, matt or
frosted effects.



a luce direzionata verso l'alto e verso il basso di Corba offre alla progettazione illuminotecnica la possibilità di creare punti luce dal forte impatto architettonico.

Corba's vertically oriented light beams can be used to create spotlight effects highlighting specific architectural features when planning a lighting project.





CORBA

APPLIQUE

Lampada con struttura in alluminio pressofuso, diffusore in metacrilato. Disponibile nei colori bianco opaco, tortora, piombo opaco, oro opaco, anticato acciaio ed anticato bronzo. Sorgente luminosa LED dimmerabile. Illuminazione indiretta.



Lamp with die-cast aluminium structure and metacrylate diffuser. Available in matt white, dove grey, matt lead, matt gold, antique steel and antique bronze. Dimmable LED light source. Indirect illumination.

Dimmer compatibile disponibile a pag. 240.

Compatible dimmer available on page 240.







CORBA A

2 moduli LED
2x13W = 26W
220/240V
2600lm
3000K - CRI >80
Class A+

Disponibili su richiesta moduli con temperatura 2700K o 4000K. 2700K or 4000K temperature modules available on request.

FINISHES

CODE

	Anticato acciaio / Antique steel	CORBA A AA
	Anticato bronzo / Antique bronze	CORBA A AB
	Bianco opaco / Matt white	CORBA A B
	Oro opaco / Matt gold	CORBA A O
	Piombo opaco / Matt lead	CORBA A P
	Tortora / Dove Grey	CORBA A T

KAMAK
APPLIQUE

Il fascino misterioso
dell'eclissi.
The mysterious
allure of the eclipse.

Kamak è l'espressione di un dualismo inscindibile, un abbraccio che illumina l'ambiente con una luce avvolgente. Questa lampada da parete arreda gli spazi con il suo design semplice, dalle linee pulite e così ben definite da ricordare l'affascinante fenomeno dell'eclissi: il bacio tra il sole e la luna.

Kamak is the expression of an inseparable dualism, an embrace that illuminates the environment with an enveloping light. This wall lamp features a simple design with well-defined lines that recall fascinating phenomenon of an eclipse: when the sun and the moon embrace.





Nella materia pura è racchiusa tutta la potenza della natura. Sta a noi saperla svelare e valorizzare.

Pure matter contains all the power of nature. It is up to us to unleash and enhance it.



KAMAK

APPLIQUE

Lampada con struttura in alluminio, diffusore in metacrilato. Disponibile nei colori bianco opaco e tortora.

Sorgente luminosa COB LED dimmerabile.

Illuminazione indiretta.

Lamp with aluminium structure and metacrylate diffuser. Available in matt white and dove grey. Dimmable COB LED light source. Indirect illumination.

Dimmer compatibile disponibile a pag. 240.

Compatible dimmer available on page 240.



KAMAK AL

1 COB LED
15W
220/240V
1350lm
3000K - CRI >80
Class A+

KAMAK AS

1 COB LED
10W
220/240V
900lm
3000K - CRI >80
Class A+

FINISHES	CODE	CODE
<input type="checkbox"/> Bianco opaco / Matt white	KAMAK AL B	KAMAK AS B
<input type="checkbox"/> Tortora / Dove Grey	KAMAK AL T	KAMAK AS T

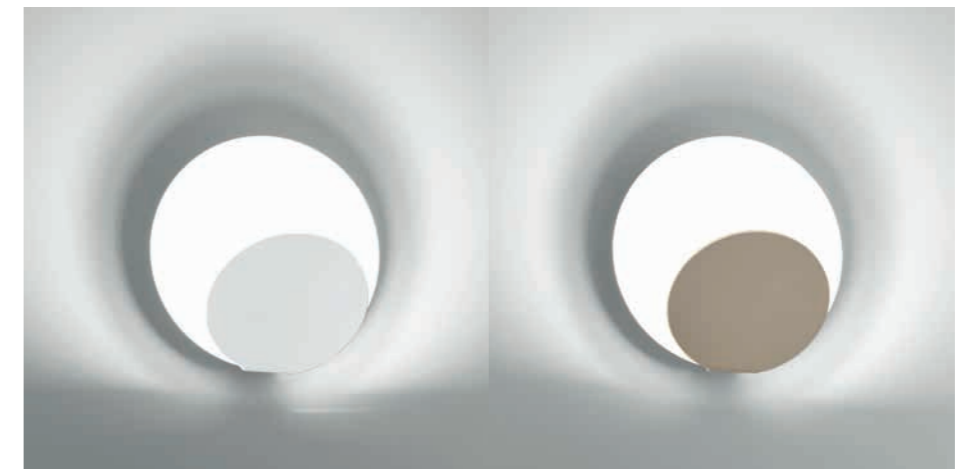

DIMMER

Per tutti gli articoli con moduli LED dimmerabili utilizzare un solo dimmer. Per Drop S2 e Mikado PL utilizzare 2 dimmer con modalità Master/Slave.

Use only one dimmer for all items with dimmable LED modules. For Drop S2 and Mikado PL use 2 dimmers in Master/Slave mode.

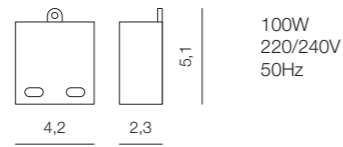

100W
220/240V
50Hz

CONDIZIONI DI VENDITA GENERALI

- Le descrizioni e le illustrazioni dei prodotti devono intendersi a titolo indicativo. Pertanto GIARNIERI si riserva il diritto di fare tutte le modifiche per migliorare il prodotto senza obbligo di preavviso.
- L'imballo è compreso nel prezzo.
- Non verranno accettati ritorni di merce se non preavvisati e da noi espressamente autorizzati.
- Spedizione sempre in porto franco senza alcun minimo d'ordine.
- Non verrà addebitato nessun costo aggiuntivo per il contributo RAEE sostenuto dall'azienda.
- Per ogni controversia è competente il Foro di Foggia.

GENERAL SALES CONDITIONS

- Strict accuracy of descriptions and illustrations of the products cannot be guaranteed. Therefore due to its policy of product improvement, GIARNIERI reserves the right to make any changes without notice.
- Packing is included free of charge.
- No goods may be returned without previous GIARNIERI's written permission.
- The RAEE costs will be hold from our company.
- All legal actions to take place under the jurisdiction of the Foggia Authorities.

© Copyright GIARNIERI

Direzione Artistica
Mario Cappelletto

Pre-press
Asolana Group

Print
Tipografia Asolana
Luglio 2019

Photos
Asolana Group

È vietata la riproduzione anche parziale di questo catalogo.
It is forbidden to reproduce any part of this catalogue.

GIARNIERI
contemporary light

GIARNIERI brand of G.E.A. Luce S.r.l.
Via Teodoro Tardio snc
71016 - San Severo (FG) Italy
Tel +39 0882 373016
Fax +39 0882 336934
www.giarnierilight.com
info@giarnierilight.com



giarnierilight.com

