

V I S I O N



S I L L U X



V I S I O N

VISION, VUOLE ESSERE UN CONTATTO TRA DESIDERI E FORME, IN UN CRESCENDO DI SUGGERZIONI, SPUNTI E PENSIERI CHE SI MATERIALIZZANO.

VISION; IMMAGINARE E DAR FORMA ALLE NOSTRE VISIONI PIÙ IMPROBILI, ARRAMPICARSI VERSO LE SCOGLIERE MENO SICURE MA PIÙ ENTUSIASMANTI - VISIONE - QUALE FEDE ORIGINARIA DEI NOSTRI PERCORSI.

“VISION” WANTS TO BE A LINK BETWEEN DESIRES AND FORMS, A CRESCENDO OF SUGGESTIONS, IDEAS AND THOUGHTS CAST IN MATERIAL FORM.

VISION: OUR MOST UNLIKELY VISIONS TO IMAGINE AND TO SHAPE, THE LESS SAFE BUT THE MOST EXCITING REEF TO CLIMB - VISION - AS THE ORIGINAL FAITH OF OUR ROUTES.

S I L L U X

W A G O N - S T A R

O R I A N O F A V A R E T T O

PERDERSI NELLA GALASSIA CON IL NOSTRO CARRO DI STELLE.
GETTING LOST IN THE GALAXY WITH OUR STARS' WAGON.

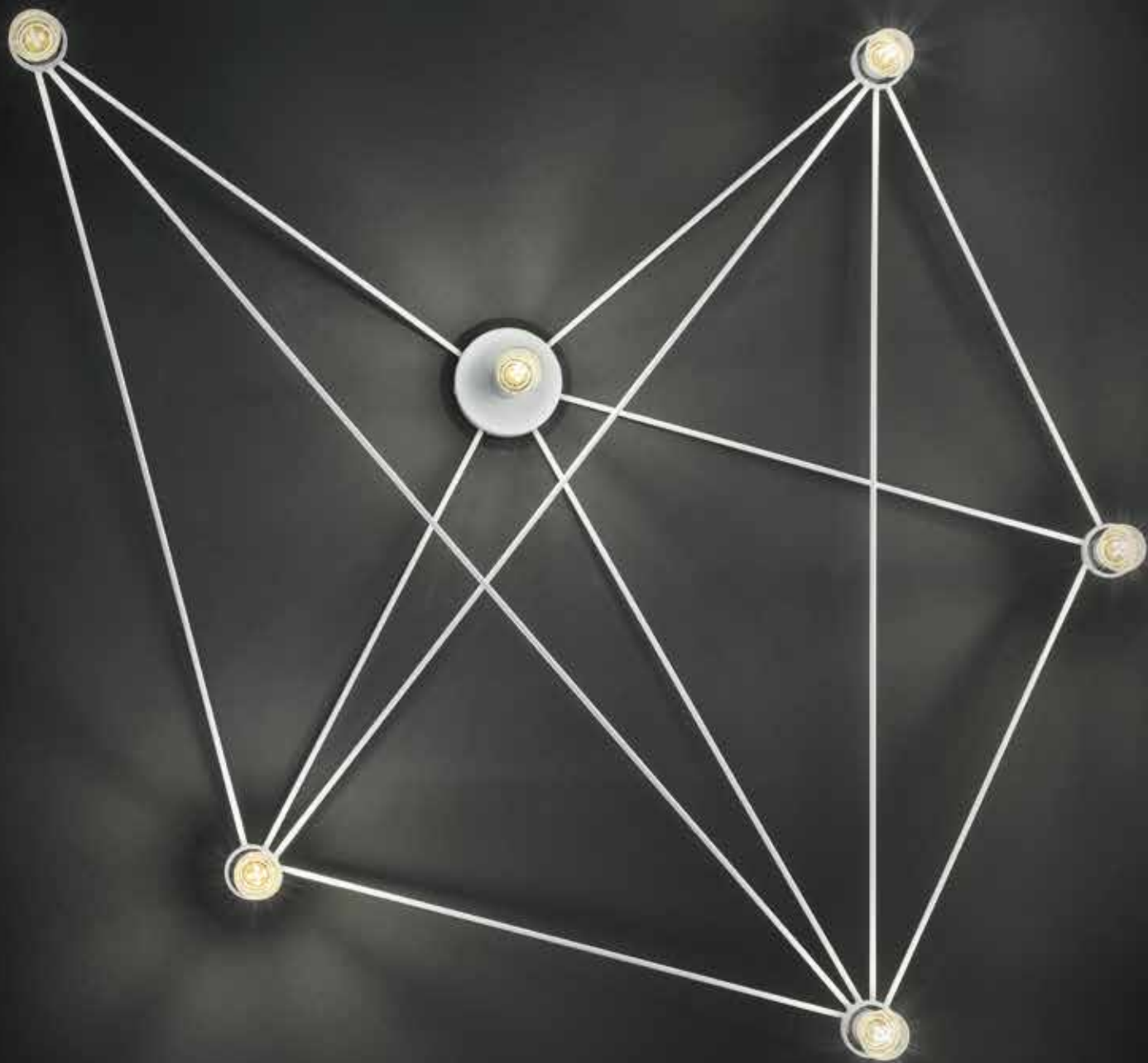

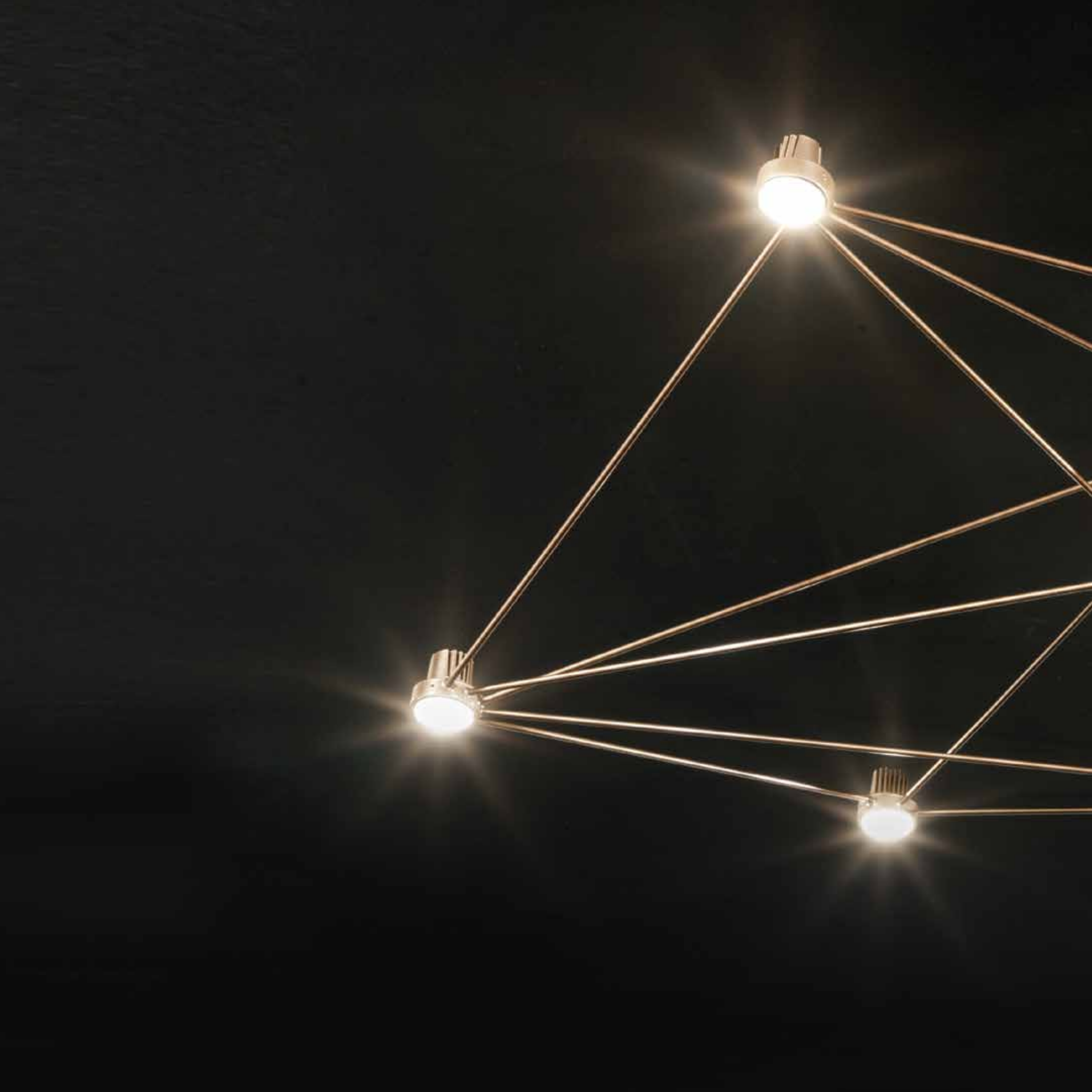



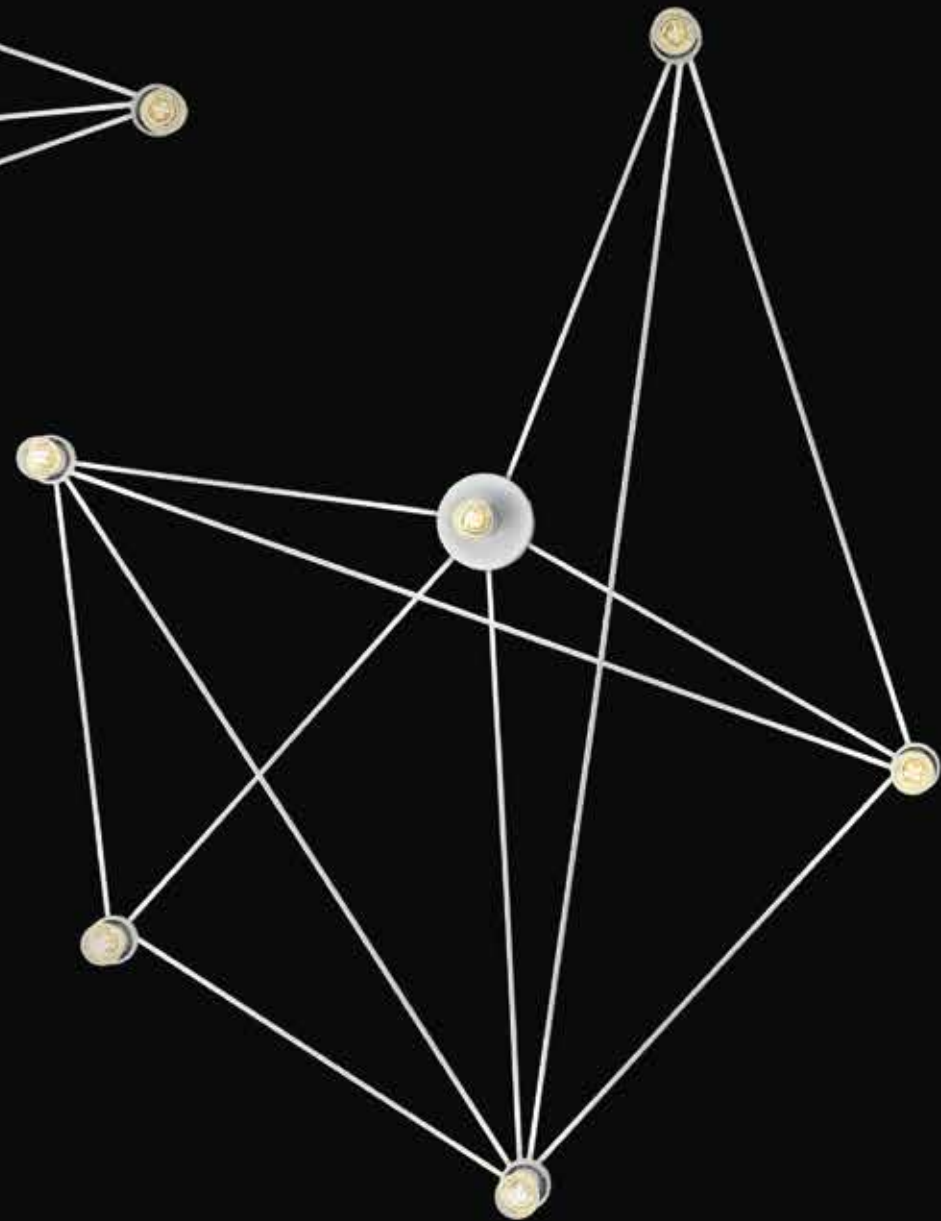
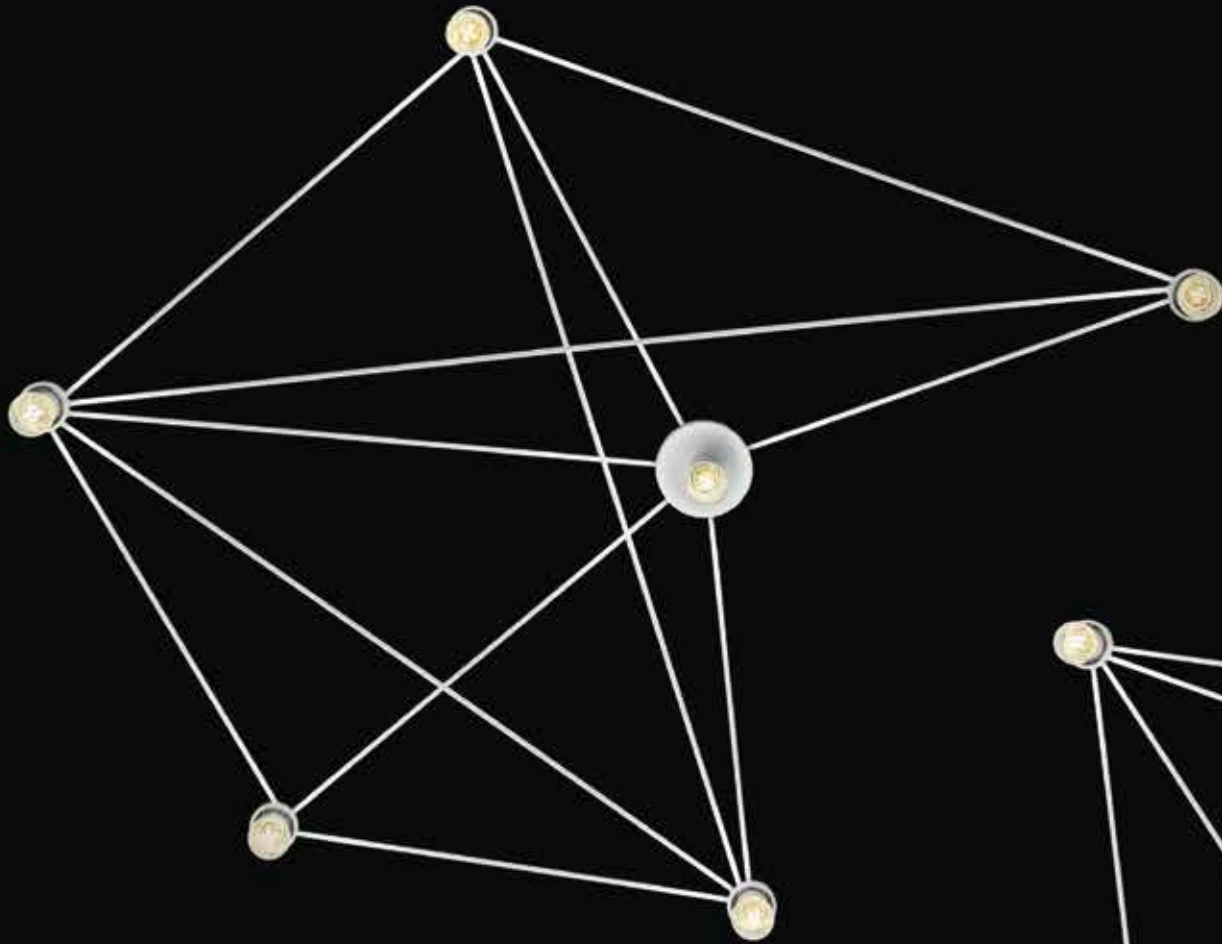

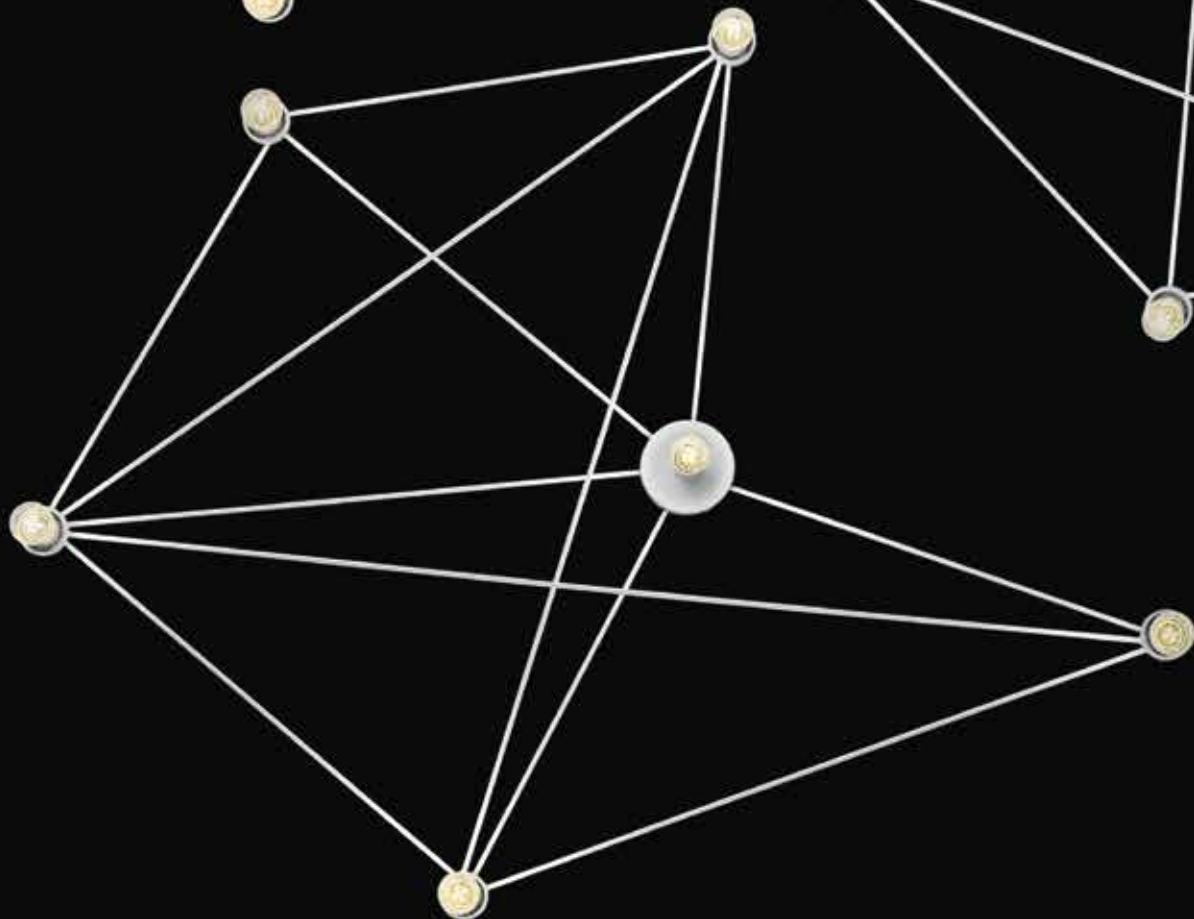
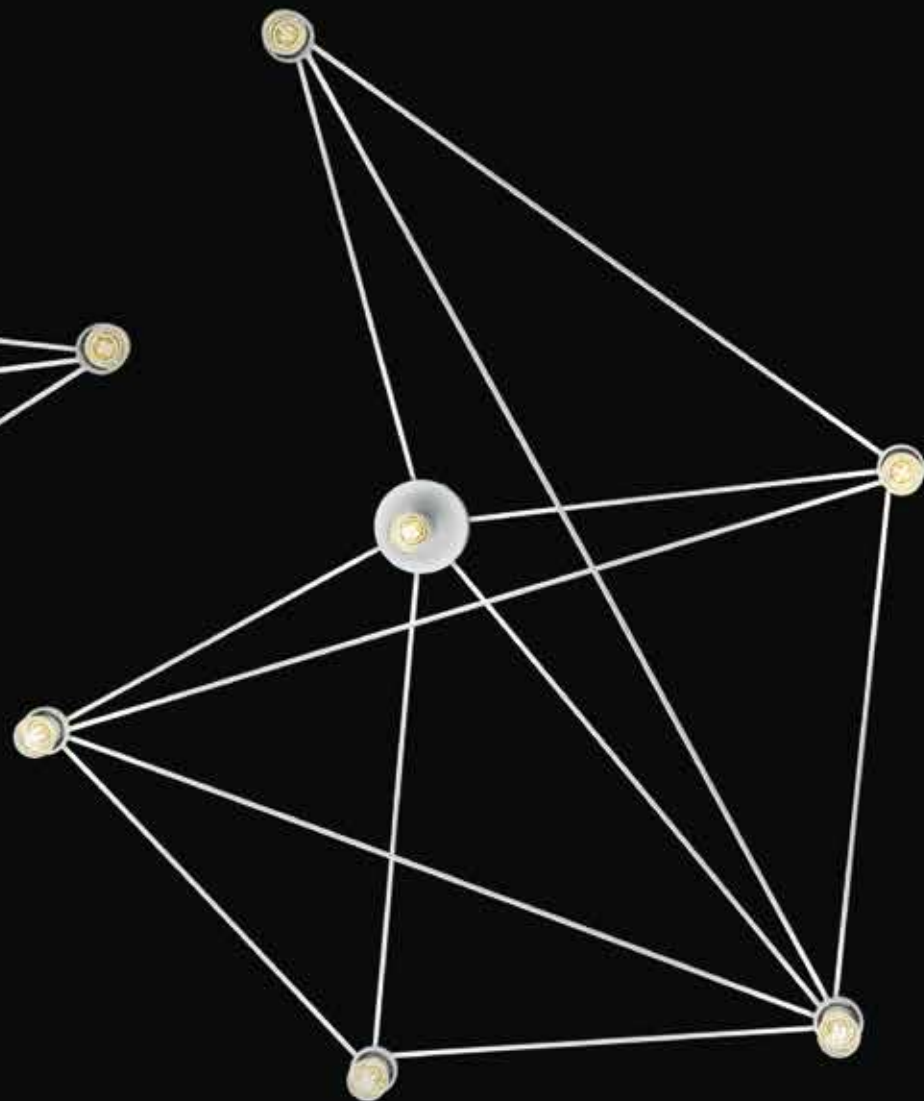
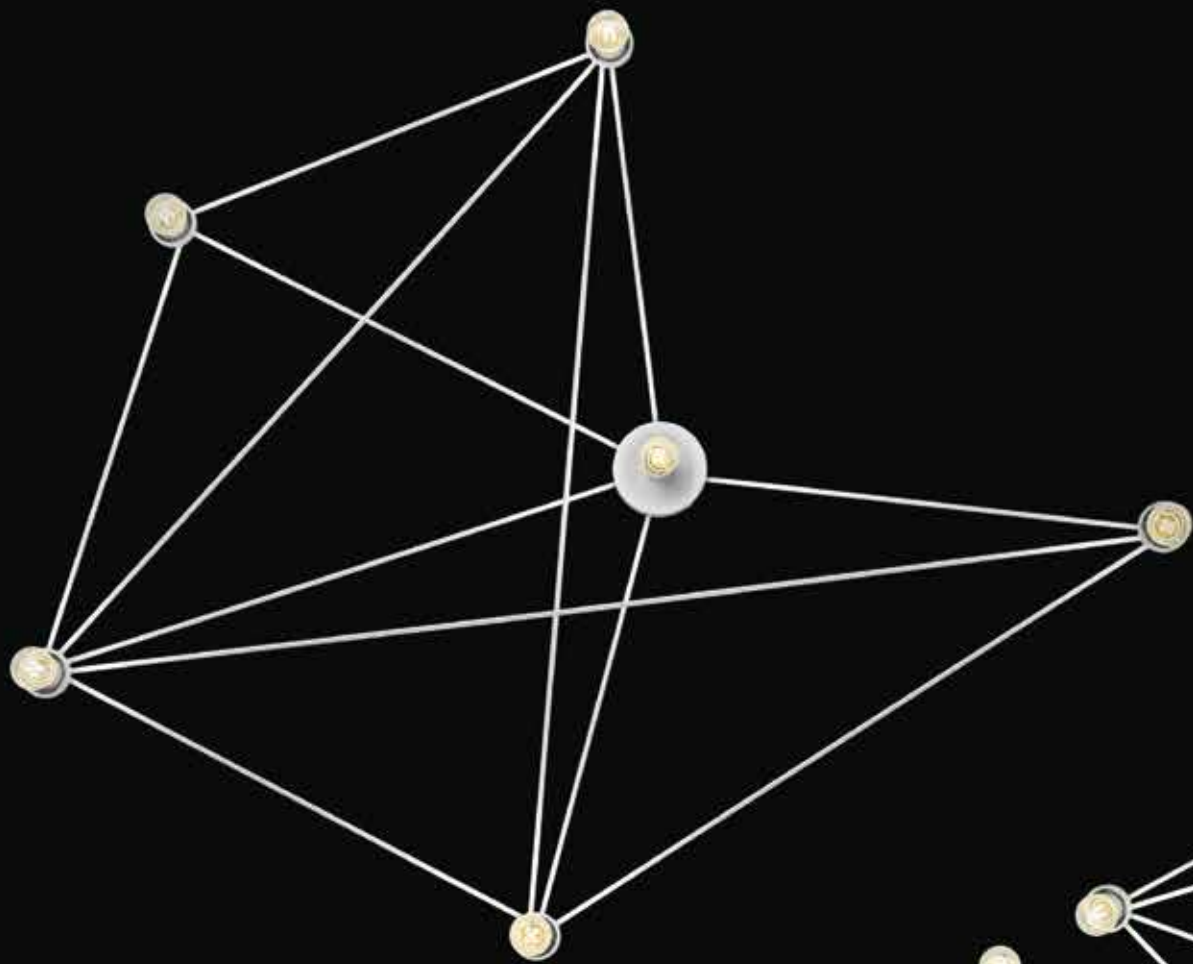



LP 6/323

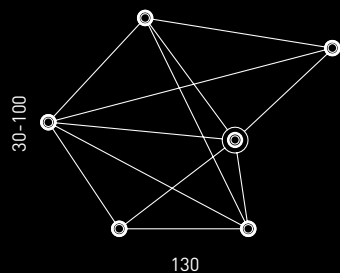

LS 5/323
LED 3600 lumen 2700K o/or E14
CE IP20

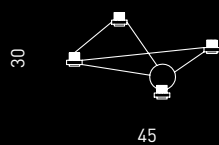

LP 6/323
LED 2800 lumen 2700K o/or E14
CE IP20



LED RIMOVIBILE
REMOVABLE LED

MONTATURA - FRAME



40
laccato
bianco
lacquered
white



64
laccato
bronzo
lacquered
bronze

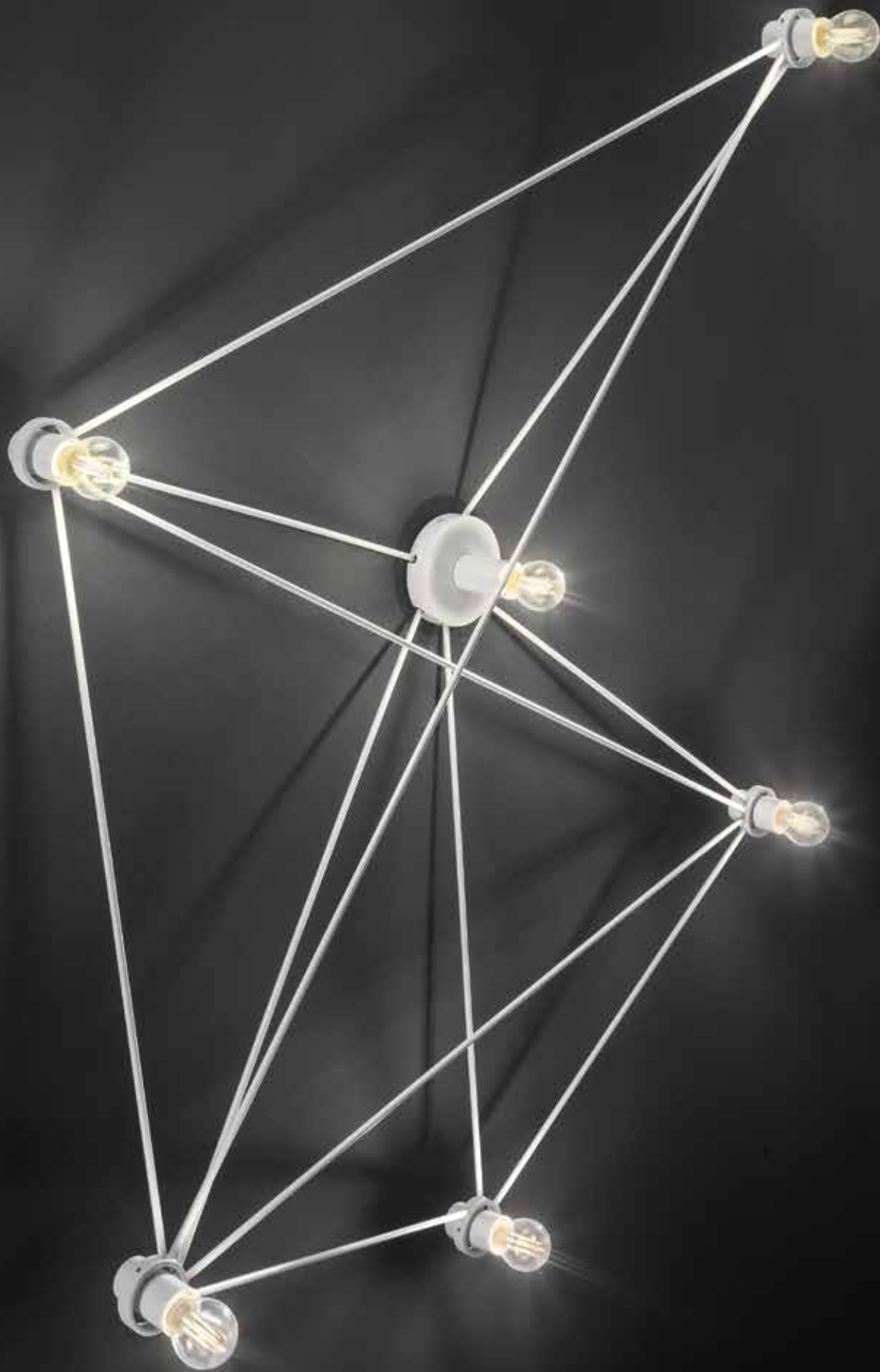

B O M - B O N

STUDIO TEAM DESIGN

UN SOFFIO LEGGERO CHE MUTA COME I COLORI DELL'IRIDE.
A LIGHT BREEZE THAT CHANGE AS THE IRIS COLOUR.



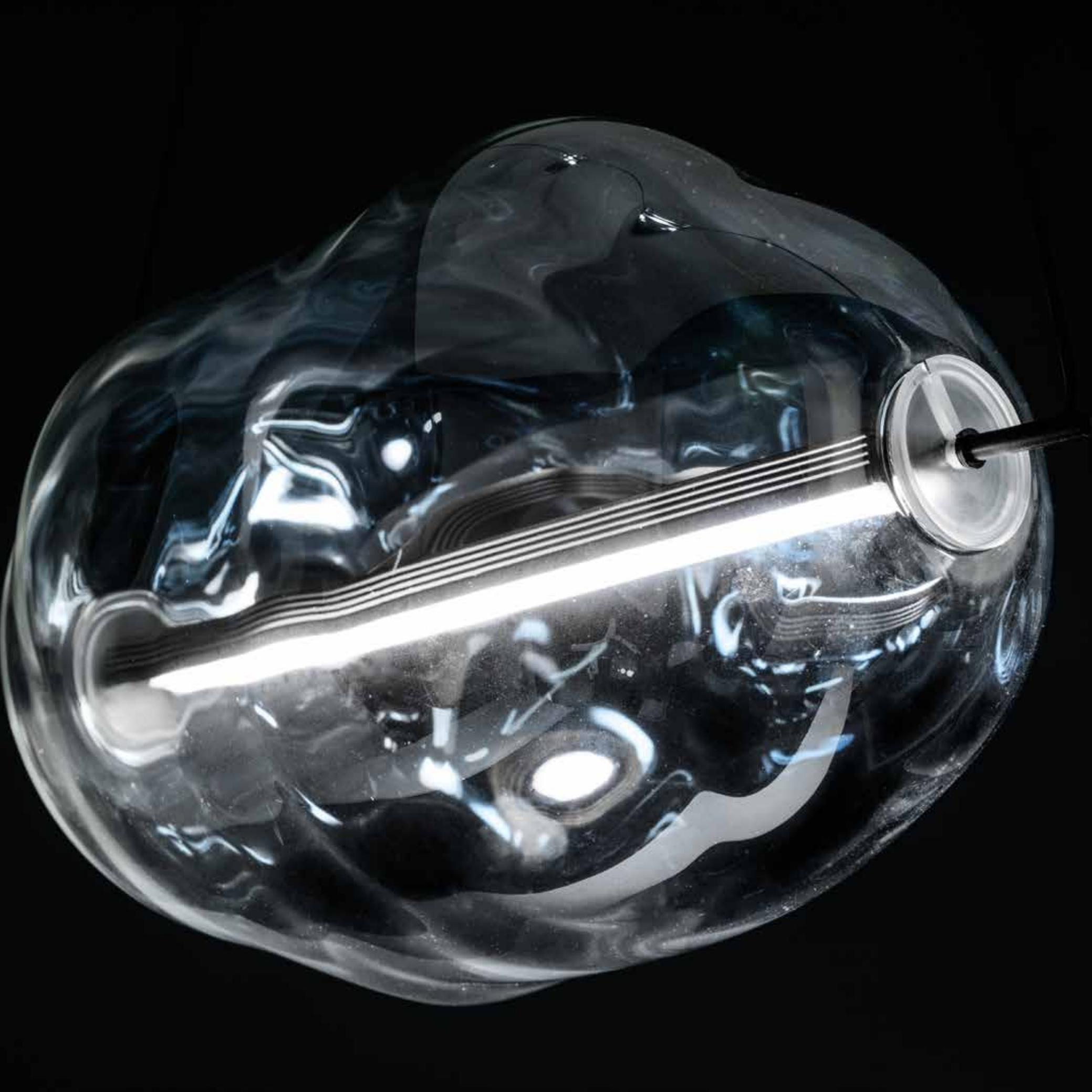



SP 8/324





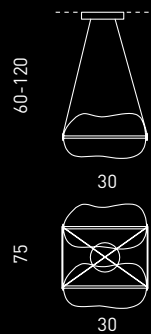

SP 8/324
2 x 14W LED 4000 lumen 3000K
CE IP20 ▽

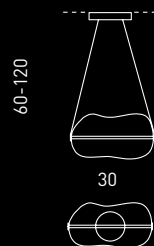

SP 7/324
1 x 14W LED 2000 lumen 3000K
CE IP20 ▽

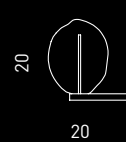

LP 6/324
1 x 8W LED 600 lumen 3000K
CE IP20 ▽

DIFFUSORE - LAMPSHADE



10
cristallo trasparente iridescente
iridescent clear glass

MONTATURA - FRAME



31
cromo
chrome



O C E A N

ARMANDO D'ANDREA

UN FUTURO PROSSIMO CON LA FORZA DI UNA DISTESA DI TRONCHI.
A NEAR FUTURE WITH THE STRENGTH OF A TRUNKS' EXPANSE.



SP 8/322

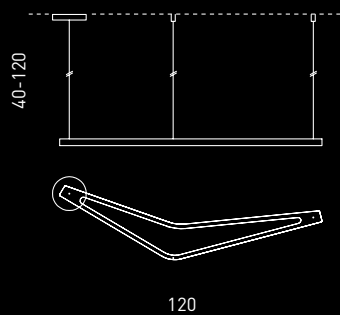

SP 8/322
STRIP LED 3500 lumen 3000K
CE IP20

DIFFUSORE - LAMPSHADE



01
plexiglass
opalino
opaline
plexiglass

MONTATURA - FRAME



40
laccato
bianco
lacquered
white



42
laccato
grigio
lacquered
grey



S M I L E

ORIANO FAVARETTO

SEMPlicità E IRONIA IN UN CONTINUO SFUMARE DI SORRISI.
SIMPLICITY AND IRONY IN A CONTINUOUS SHADE OF SMILES.



PI 3/321

ORIENTABILE/ADJUSTABLE

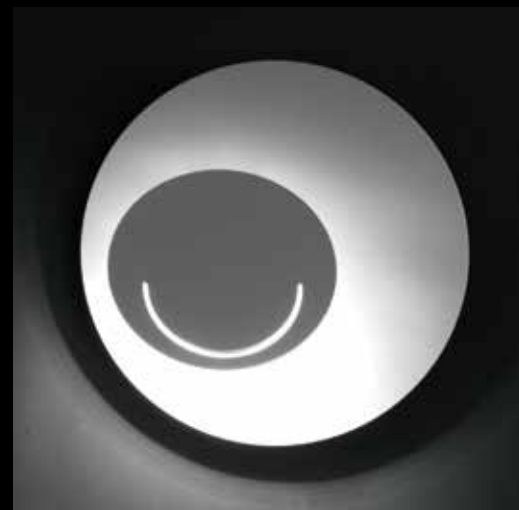
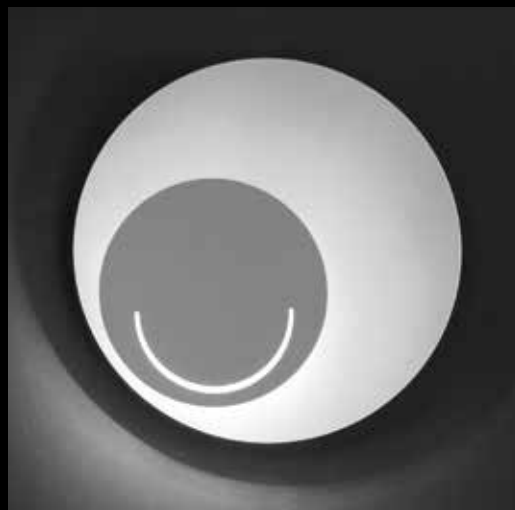



LP 6/321 A











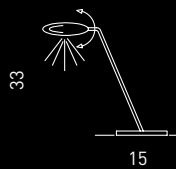

LT 1/321
LED 650 lumen 2700K
CE IP20

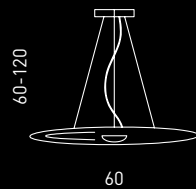

SP 8/321
5 LED 3250 lumen 2700K
CE IP20

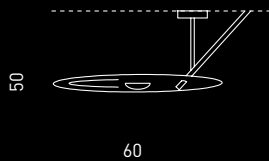

LS Q/321
5 LED 3250 lumen 2700K
CE IP20

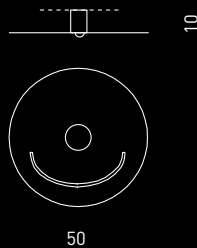

LS 5/321
1 x 12W LED + 35 watt LED
3100 lumen 3000K
CE IP20

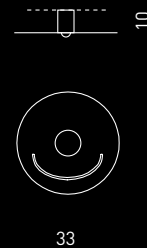

LS 4/321
1 x 12W LED + 24 watt LED
2100 lumen 3000K
CE IP20

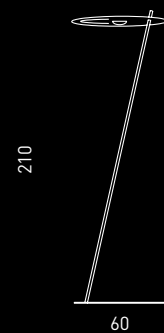

PI 3/321
5 LED 3250 lumen 2700K
CE IP20

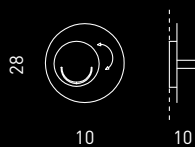

LP 6/321 A
LED 650 lumen 2700K
CE IP20

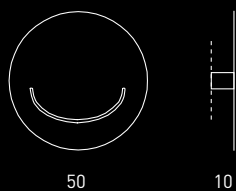

LP 6/321 C
35W 3100 lumen 3000K
CE IP20

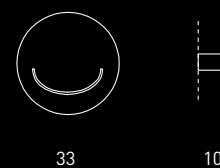

LP 6/321 B
24W 2100 lumen 3000K
CE IP20

MONTATURA - FRAME



38 laccato oro lacquered gold	40 laccato bianco lacquered white	45 laccato nero lacquered black
---	---	---



K A L Ì

STUDIO TEAM DESIGN

LA DEA CHE TUTTO PUÒ CI AVVOLGE DI MERAVIGLIE.
THE GODDESS WHO EVERYTHING CAN, WRAPS US OF WONDERS.



SP 8/320







LP 6/320 A



SP 7/320

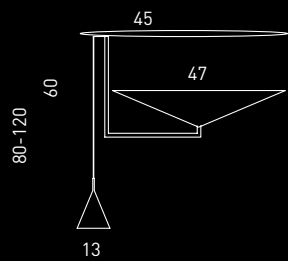

SP 8/320
1 x E27 + GU10 7,2WLED
CE IP20

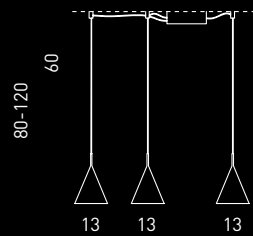

SP 7/320
3 x GU10 7,2W LED
CE IP20

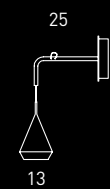

LP 6/320 A
1 x GU10 7,2W LED
CE IP20

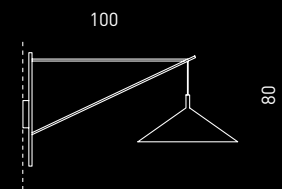

LP 6/320 C
12W LED 1200 lumen 2700K
o/or E27
CE IP20

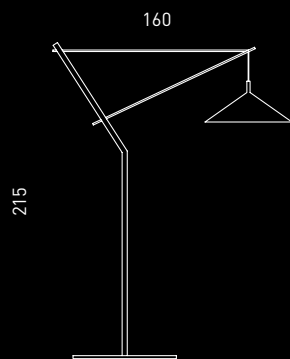

PI 3/320
12W LED 1200 lumen 2700K
o/or E27
CE IP20

DIFFUSORE - LAMPSHADE



01
cristallo
acrilico
acrylic
cristal

61
bronzo
bronze

MONTATURA - FRAME



38
laccato
oro
lacquered
gold

40
laccato
bianco
lacquered
white

64
laccato
bronzo
lacquered
bronze



LP 6/320 C



F U T U R A

O R I A N O F A V A R E T T O

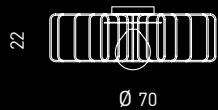

SEGNI INFINITI IN UN CONTINUO PERCORSO VERSO LO SPAZIO.
COUNTLESS SIGNS IN A CONTINUOUS PATH TO SPACE.



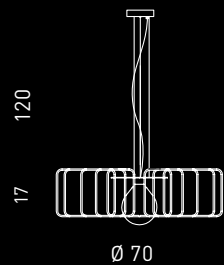

LS Q/283-70
1 x max 46W E27 
CE 



SP 8/283-70
1 x max 46W E27 
CE 

MONTATURA - FRAME



38
laccato
oro
lacquered
gold



39
grigio
ferro
iron
grey



60
corten
corten



LS Q/283-70

V I S I O N 2 0 1 7

S I L L U X



I
N
S
T
A
L
L
A
T
I
O
N





INDEX

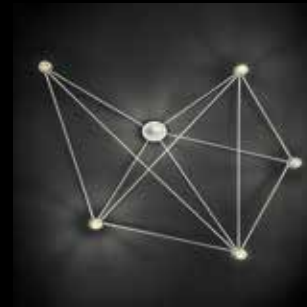

WAGON-STAR
P 4



BOM-BON
P 12



OCEAN
P 20



SMILE
P 24



KALÌ
P 36



FUTURA
P 44



















SIL



**TUTTI I PRODOTTI SILLUX SONO ORIGINALI E REALIZZATI IN ITALIA.
SILLUX PRODUCTS ARE MADE IN ITALY.**

LAMPADINE / BULBS / BOMBILLAS / LEUCHTMITTEL / AMPOULES

CLASSE ENERGETICA
ENERGETIC CLASS

 E27	220V	60W → 46W	ECO	D
		75W → 57W	ECO	D
		100W → 77W	ECO	D
		150W → 116W	ECO	D
 E27	220V	150W → 100W	ECO	D
 E14	220V	60W → 42W	ECO	D
 G9	220V	40W → 33W	ECO	D
		60W → 48W	ECO	D
 R7s 78 mm	220V	60W → 48W	ECO	C
		100W → 80W	ECO	D
		150W → 120W	ECO	C
 R7s 114 mm	220V	120W → 120W	ECO	D
		200W → 160W	ECO	C
 QR111	220V	50W	ECO	B
 GZ10	220V	42W	ECO	D
 T5	220V	39W	ES ENERGY SAVING	A+
		80W	ES ENERGY SAVING	A+
 G24Q-3	220V	26W	ES ENERGY SAVING	A
		36W	ES ENERGY SAVING	A
 2 GX 13	220V	22W	ES ENERGY SAVING	A+
		40W	ES ENERGY SAVING	A+
 E27 Ø 95 mm	220V	20W	ES ENERGY SAVING	A
 E27	220V	18W	ES ENERGY SAVING	A
 E14	220V	11W	ES ENERGY SAVING	A
 2G11	220V	55W	ES ENERGY SAVING	A
 G4	12V	14W	ECO	B
 GY 6,35	12V	25W	ECO	B
 GU10 LED	220V	3,6W		A+
 LED	12V/350mA			A

ECO Lampadine alogene di nuova generazione, a risparmio di energia.
New generation halogen bulbs, in energy saving.

ES Apparecchio che può contenere lampadine fluorescenti a risparmio energetico.
This lighting fixture is suitable for Energy saving bulbs.

I lumen sono espressi in valori nominali
Lumens are expressed in nominal values.

L'Azienda si riserva di apportare in qualsiasi momento ogni modifica o miglioramento ritenga utile al mantenimento dei massimi standard di qualità nei prodotti illustrati nel presente catalogo.

The company reserves the right to make all changes or improvements anytime it believes to be useful to guarantee the highest quality standards of the products illustrated in this catalogue.

Printed in Italy by Silegrafiche

Giuseppe Saccon - Amministratore
Claudio Saccon - Resp. tecnico
Luca Saccon - Resp. magazzino e fornitori
Giorgio Farinazzo - Resp. progetto
Sabina Martinuzzi - Commerciale estero e Italia
Oriano Favaretto - Art director

Beatrice Favaretto - Concept catalogo

Studio Pointer - foto

S I L L U X[®]

I-30020 QUARTO D'ALTINO (VE)
VIA GIOVANNI PASCOLI, 35/A
PH:+39.0422.824756 FAX:+39.0422.824777
WWW.SILLUX.COM INFO@SILLUX.COM



YouTube



